

DIGITAL I.C. AS AUDIO MIXER

JULY 1967
Three Shillings

SEP 11 1967

Wireless World

ELECTRONICS
TELEVISION
RADIO • AUDIO

ASH LIBRARY

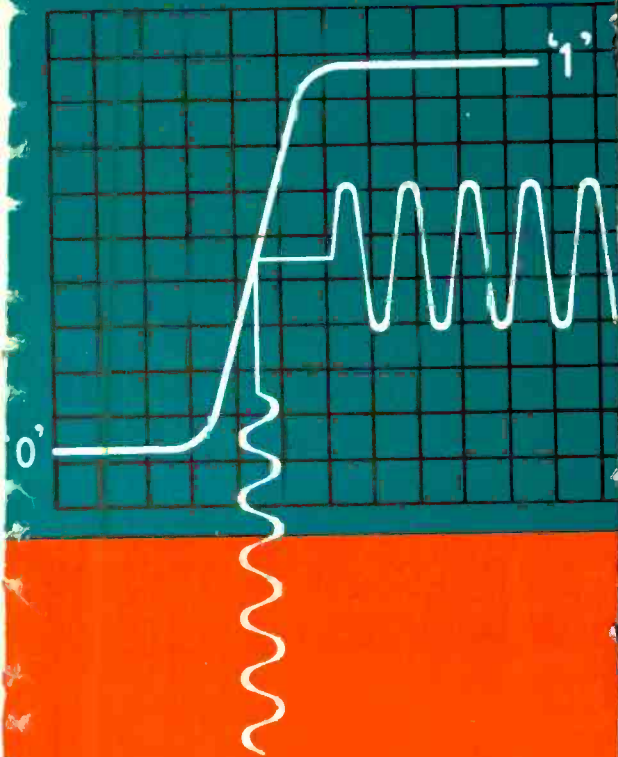

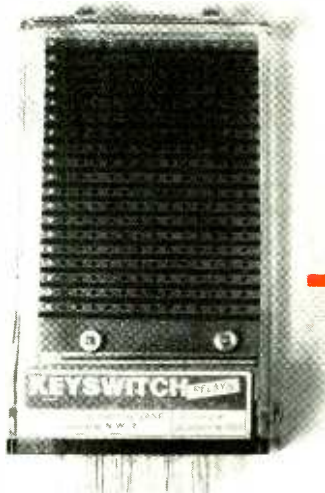

Keyswitch P304 chassis transparent cover 22 A.C. plug & socket

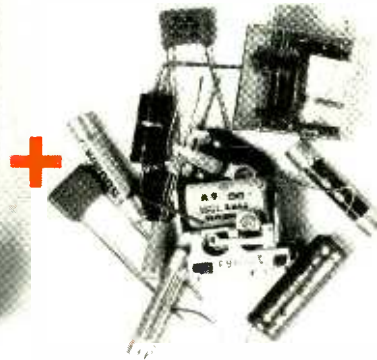

your components

=



or

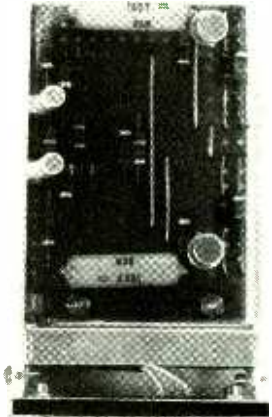

or

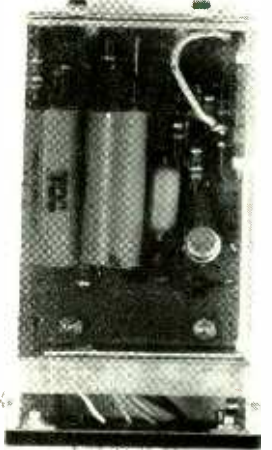

your circuit with built-in solder strips

assembled units courtesy of South London Electrical Equipment Co. Ltd.

We've got the biggest little chassis in town

SAVE TIME & MONEY with precision-built Keyswitch plug-in chassis. They're the ideal way to put a handful of circuitry together, and not necessarily a small handful either. Even relays and small motors can be mounted in these versatile units. Here's your choice of mounting space:

Keyswitch P304S - 5 3/4 in³

Keyswitch P304 (illustrated) - 7 1/2 in³

Keyswitch 2P304 (with 44-way connectors) - 15 in³

Whether you use your own mounting board, or the

optional Keyswitch printed-circuit board with its mounting-hole grid backed by interconnecting copper strips, you have an infinite variety of circuit and layout possibilities. And all this for as little as 15/- a time, from Keyswitch Relays Ltd, 120 Cricklewood Lane, London NW2; telephone 01-452 3344; telex 262754.



WW-001 FOR FURTHER DETAILS

Wireless World

ELECTRONICS, TELEVISION, RADIO, AUDIO

JULY 1967

Editor-in-chief:

W. T. COCKING, F.I.E.E.

Editor:

H. W. BARNARD

Technical Editor:

T. E. IVALL

Editorial:

B. S. CRANK

F. MILLS

G. B. SHORTER, B.Sc.

Drawing Office:

H. J. COOKE

Production:

D. R. BRAY

Advertisements:

G. BENTON ROWELL
(Manager)

J. R. EYTON-JONES

Iliffe Electrical Publications Ltd.,
Chairman: W. E. Miller,
M.A., M.I.E.R.E.
Managing Director: Kenneth Tett
Dorset House, Stamford Street,
London, S.E.1

© Iliffe Electrical Publications Ltd., 1967. Permission in writing from the Editor must first be obtained before letterpress or illustrations are reproduced from this journal. Brief extracts or comments are allowed provided acknowledgement to the journal is given.

VOLUME 73 No. 7

PRICE: 3s.

FIFTY-SEVENTH YEAR
OF PUBLICATION

- 313 Common Standards for Components
- 314 Integrated Circuit Stereo Mixer and Pre-amplifier *by A. J. McEvoy*
- 318 Ring-of-two Reference *by P. Williams*
- 323 Montreux Television Symposium and Show
- 328 Thyristor Speed Control for Electric Drill Motors *by K. C. Johnson*
- 331 Sorting out the Colour Signals *by T. D. Towers*
- 336 Regulated Power Supply with Overload Protection *by P. F. Ridler*
- 343 RC Notch Filter *by G. W. Short*
- 344 Negative Feedback Equalizer *by G. A. Steven*
- 350 New Products at Recent London Shows
- 360 Improved Television A.G.C. *by C. H. Banthorpe*
- 361 Spot Beam Photoelectric Relay *by P. Cowan*

SHORT ITEMS

- 322 Stereo Decoder Input Impedance
- 324 High Resolution Radar for London Airport
- 324 Colour Television in Europe
- 324 New Space Science Laboratory Opened
- 324 Stockholm Telecommunications Tower
- 359 Mobile 6 ft Satcom Terminal

REGULAR FEATURES

- | | |
|----------------------------|---------------------------------|
| 313 Editorial Comment | 342 H.F. Predictions |
| 317 Books Received | 350 New Products |
| 324 World of Wireless | 359 Conferences and Exhibitions |
| 326 Personalities | 362 News from Industry |
| 330 World of Amateur Radio | 364 Real and Imaginary |
| 340 Letters to the Editor | |

PUBLISHED MONTHLY (3rd Monday of preceding month). Telephone: 01-928 3333 (70 lines).
Telegrams Telex: Wlworld Iliffepres 25137 London. Cables: "Ethaworld, London, S.E.1."
Annual Subscriptions: Home: £2 6s Od. Overseas: £2 15 Od. Canada and U.S.A.: \$8.00. Second-Class
mail privileges authorised at New York N.Y. BRANCH OFFICES: BIRMINGHAM: 401,
Lynton House, Walsall Road, 22b. Telephone: Birchfields 4838. BRISTOL: 11 Marsh Street, 1.
Telephone: Bristol 21491/2. COVENTRY: 8-10, Corporation Street. Telephone: Coventry
25210. GLASGOW: 123, Hope Street, C.2. Telephone: Central 1265-6. MANCHESTER:
260, Deansgate, 3. Telephone: Blackfriars 4412. NEW YORK OFFICE U.S.A.: 300
East 42nd Street, New York 10017. Telephone: 867-3900

The Capacitor Crescendo by Mullard

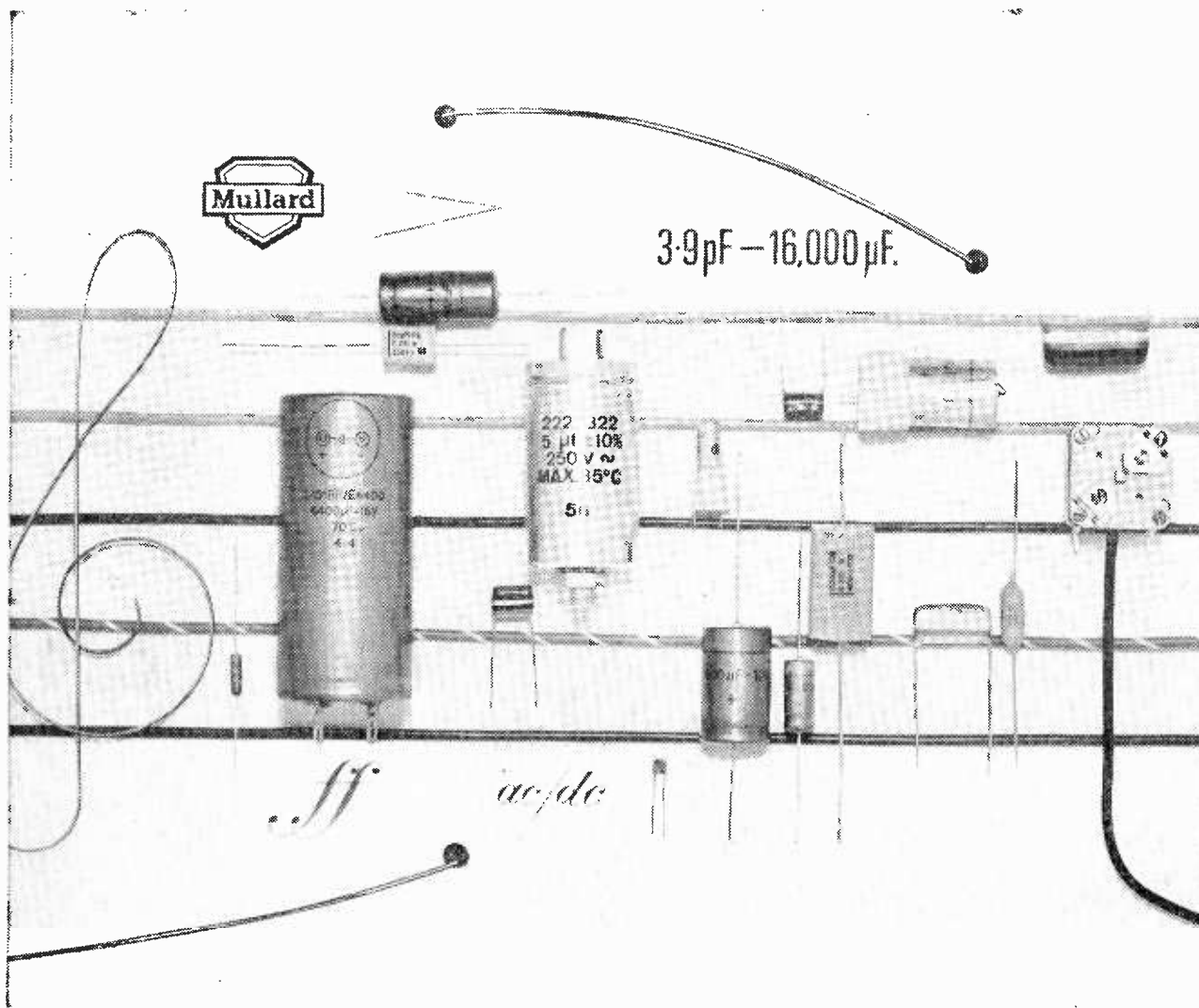

Ex-stock delivery, competitive prices—music to any radio and TV setmaker's ears. But when you add Mullard quality and Mullard reliability you can see we're adding up to something big. It's the old problem. How do you keep a competitive edge on your products without the price creeping up? Improve quality and reliability without cutting the profits? You choose from the eleven Mullard ranges which cover 3.9pF to 16,000µF. Or tell us your requirements. You buy in bulk—just name the quantities. And you get them ex-stock.

NT1038

The usual ranges are available in :—
 Foil/Film ; Metallised Polyester Foil ; Metallised Polycarbonate Foil ; Aluminium Electrolytic ; Tantalum Electrolytic ; Plate Ceramic and Solid Dielectric Tuning for AM or AM/FM.

Send for information to Mullard Limited, Consumer Electronics Division, Mullard House, Torrington Place, London WC1. Or Telephone 01-580 6633.

Mullard

EMD 177

WV—086 FOR FURTHER DETAILS

Wireless World

ELECTRONICS, TELEVISION, RADIO, AUDIO

Common Standards for Components

BETWEEN the usual grey covers and in the usual sober language, a recent British Standard* presents, unexpectedly, a plan of action for a bold scheme that will have far-reaching effects on the British electronics industry—eventually perhaps on the electronics industries of all Western Europe. This B.S. is, in fact, the first step in putting into force the Burghard Report†, which recommends the establishment of a U.K. system of common standards for electronic components, to replace the multiplicity of specifications (B.S., DEF, CV, etc.) at present in use. The standardization applies basically to performance specification and to quality. The idea behind the scheme is to “make it possible for the maximum economic benefits to be derived from more extensive mass production, and for performance data to be obtained and accumulated from standardized acceptance tests based on this larger scale production.”

The authority of the scheme rests on the fact that it is virtually guaranteed by the British Government. If a manufacturer wishes to sell a component conforming to one of the new standards he has to do more than just write a specification in the required manner: he must first obtain approval for his inspection facilities from the scheme's management body and then undertake tests to establish official acceptance of the component. Vetting of inspection facilities will in fact be done by the Ministry of Technology's Electrical Inspection Directorate, acting as agents for the management body.

Thus these new standards on electronic components will have somewhat more power and authority than the usual British Standards. A further indication of the importance of electronics to the country's economy is that this scheme appears to be the first instance of a special management body concerned with a particular class of products being set up within the B.S.I. All sides of the electronics industry—component manufacturers and users—have been co-operating enthusiastically to get the scheme into operation and it looks as if a substantial number of U.K. Common Standards specifications for particular groups of components (e.g. fixed resistors, variable capacitors) will be published early next year. Integrated circuits, in spite of their inherent complexity, are likely to be quite early off the mark because they have no long history of established methods of manufacture and specification to be painfully adapted to the scheme's requirements.

Advantageous as the scheme will be within the U.K. itself, there are likely to be longer-term benefits resulting from the fact that it is really part of a much larger effort aimed at establishing common standards for electronic components throughout Europe. Already European associations of manufacturers of active and passive components have been set up and have recently agreed on general principles for the harmonization of standards. At the same time, contacts between countries at Government level are being made to provide authoritative backing for the industrial arrangements. The removal of technological barriers will be of immense benefit to trade.

Another big factor, though officials will not admit it openly, is that authoritative European common standards could become a much needed counterweight to the U.S. Government's system of “MIL” specs, which have played such a big part in assisting the American commercial invasion of Europe and in protecting the American electronics industry from European competition at home. Such a balance of power might even lead eventually to common standards on an international scale.

*BS 9000: 1967, “Specification for General Requirements for Electronic Parts of Assessed Quality.” British Standards Institution, price 15s.

†“Second Report of the Committee on Common Standards for Electronic Parts,” Ministry of Technology. H.M.S.O. Price 6s 6d. (The committee chairman was Rear Admiral G. F. Burghard.)

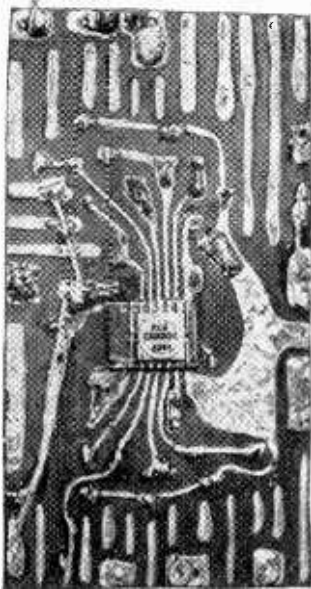

Reverse side of printed circuit of prototype; note mounting of the integrated circuit on a plastic pad supplied as part of the package in which the circuit is supplied. This spaces the i.c. off the paxolin and prevents accidental short circuits between the leads and the printed wiring.

Integrated Circuit Stereo Mixer and Pre-amplifier

Using digital i.cs for linear applications

By A. J. McEVOY, B.Sc., B.D.

THE January 1966 issue of *Wireless World* carried an interview with several leading figures in the electronics industry in the United Kingdom. In this article they gave a comprehensive review of the current state of the art in the manufacture and applications of integrated circuits. From the amateur's point of view, however, the picture presented was rather pessimistic; in fact, it was stated that "... it will be a long time before *Wireless World* can have designs for the amateur using integrated circuits." This was not because of the price factor, since this was expected to (and in fact did) drop sharply as production expanded. Rather, it was because the integrated circuit is not a component but a sub-system, and "how many amateurs want to use the kind of sub-system that we're going to sell cheaply?" This was a very reasonable question, since most of the integrated circuits in quantity production are pulse types, designed for use in computers, where the same sub-system may be incorporated hundreds or even thousands of times. The manufacturers, therefore, have little incentive to produce circuits with the linear amplifying characteristics which the amateur is more likely to require. Since then, of course, the integrated circuit has made an appearance in an American television set and a Japanese portable radio, but the statement is still generally true. The pur-

pose of this article, however, is to establish once more the truth of the old saying, "Where there's a will there's a way," by reporting on the application found for a logic circuit in a typical amateur project, an integrated circuit stereo mixer and pre-amplifier.

Design of the unit began by studying all the available data on integrated circuits available on the U.K. market. The mixer would require at least three inputs (records, radio and tape) with fair gain and very low noise. Further, it would be desirable to have a fairly high input impedance for matching both magnetic (medium impedance) and crystal (very high impedance) sources. When it was found that RCA (Great Britain) Ltd could supply a circuit described in their literature as a dual four-input gate, it seemed that further investigation would be worth while. Fig. 1 illustrates the circuit diagram of this unit. As is evident, the 14-lead flat package contains within a $\frac{1}{4}$ -in square hermetically-sealed ceramic wafer, two identical circuits, each basically a four-transistor inverter amplifier. When used in a computer circuit, an emitter follower provides the high-level (1) state, and a saturated transistor supplies the low level (0) state, at the output terminals 6 and 8. The inputs to the unit are through any one of four transistors operating in the emitter-follower mode and developing the drive to the amplifier transistors across a common emitter resistor. The unit is intended to function as a four-input NAND circuit, so that a high level output is available if any one of the inputs is in a low-level state, and a low-level output only if all four inputs are in a high-level state. The gates have the additional advantage that there is an extra input on each, which may be used for the expansion of the number of input channels by the use of external transistors. All these input options offer extra flexibility for an amateur who wishes to persuade the circuit to accept and amplify continuous rather than pulsed signals, and for whom minimum distortion is an important consideration while rise time or overshoot may be disregarded. In other words, while the diode-transistor logic system in which this unit is normally employed relies on the gates alternating between a cut-off and saturated condition, with any small fluctuations to



A. J. McEvoy, now 25 and a clergyman of the Roman Catholic Church, is a native of Larne, Co. Antrim, N. Ireland, and graduated in physics at Queen's University, Belfast, in 1963. He is at present associated with the Department of Physics, St. Patrick's College, Maynooth, Co. Kildare, Ireland, a recognized college of the National University of Ireland.

be suppressed as noise, any linear application demands stable operating conditions, and small signals superimposed on these must be amplified.

D.C. STABILIZATION

The first objective to be attained is this stabilization of the working point. It has already been pointed out that the basic element in each gate of the CD2200 d.t.l. integrated circuit is an inverting amplifier, and it will be noted from the circuit (Fig. 1) that complementary circuitry is used, with p-n-p transistors in the common-collector input sections, and n-p-ns in the amplifiers following them. If, therefore, the d.c. potential of the output at terminal 6 should tend to rise towards the "1" logic position, with Tr7 conducting and Tr8 cut off, some d.c. feedback must be applied at the input to counter this. Similarly if the above process be reversed, the falling voltage at terminal 6 or 8 if fed to one of the input transistors of the appropriate gate, would cause it to conduct more strongly, and counteract the drift. Each amplifier could then be looked on as an emitter-follower (Tr5 and Tr12) driven by the signal developed across the mixer emitter loads (R_1 and R_2), and feeding a phase-splitter (Tr6 and Tr11); the output of the pre-amp is supplied by a class A push-pull stage (Tr7, Tr8 and Tr9, Tr10). Therefore the terminals 6 and 8 must be maintained at approximately $\frac{1}{2}V_{cc}$, so that neither of the transistors in each pair can saturate or cut off, as they are designed to do, but rather rest with a small forward bias so that they can accept and amplify small signals with a minimum of distortion. However, as the operating point of the direct-coupled amplifying system is set by the voltage across the emitter resistor common to the input transistors, it follows that any stabilizing d.c. feedback arrangement must rely on regulating the current here. It was decided that, as three inputs to the mixer would be sufficient, the fourth could be utilised in the d.c. feedback loop. (It may be noted that further inputs could always be provided using the terminals 3 and 11 with additional external transistors, also operating in the emitter follower mode.) All the signal input transistors can then be operated with very small standing currents, as the working conditions will then be unaffected by them; this gives the additional advantage that the noise introduced by these, the first transistors to handle the signals, will be lower, an important point for the noise level of the circuit as a whole. It can be safely assumed that all transistors will be operating within their prescribed ratings; after all, in logic applications the inputs vary from 0 to V_{cc} , as do the outputs, so in linear operation no transistor can exceed its voltage limitations. As for current, the manufacturer's data allows up to 10 mA at the relevant inputs, and this generous rating will not be exceeded. In the output pair, up to 15 mA may be drawn from terminals 6 and 8, and as the final circuit draws only 5 mA, the currents in the transistors, which can presumably reach the figure of 15 mA, must be tolerable.

First investigations of a practical circuit were guided by the supplier's curves for static electrical specifications. If any potential divider circuit were to be chosen to supply the base of Tr1 (Tr13, channel B), joining it to terminal 6 (8) and the positive and negative lines, and taking into account the recommended value for the resistor between points 6 and 14 (8 and 14), this would

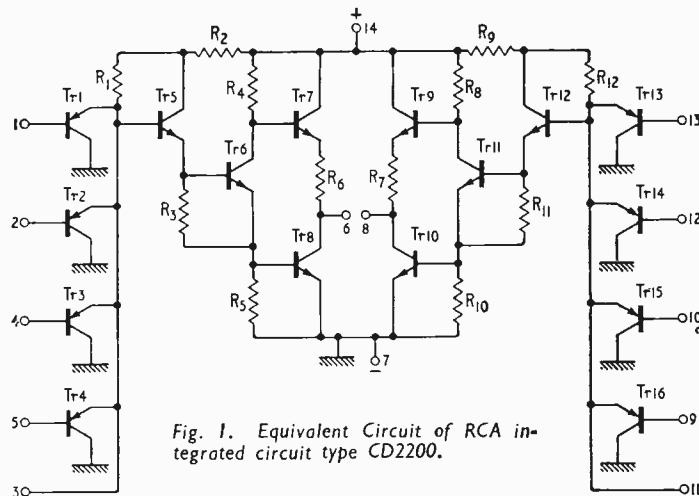
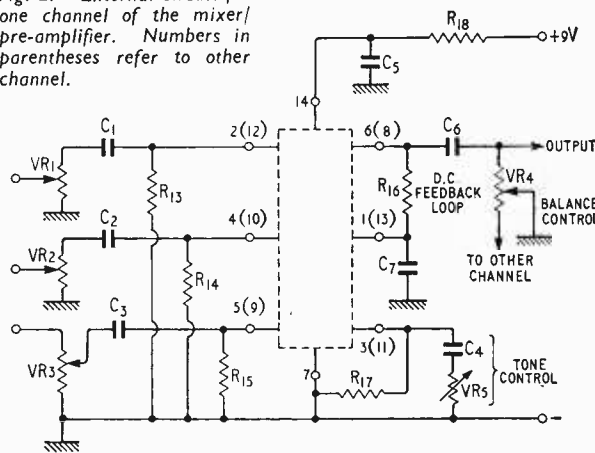

Fig. 1. Equivalent Circuit of RCA integrated circuit type CD2200.

Fig. 2. External circuit for one channel of the mixer/pre-amplifier. Numbers in parentheses refer to other channel.



form a shunt across the output, of fairly low resistance, and to some extent degrade the performance of the pre-amp when operating into a transistor power amplifier. However, there is one point on the characteristic at which the input and output terminals are at the same potential, while neither of the transistors in the output pair are near the limits of class A operation. Therefore a feasible d.c. feedback system need be no more complicated than a resistor from 6 to 1 (8 to 13), decoupled at 1 (13) by a capacitor to earth. The base current is, of course, small so there is no significant voltage drop across the resistor; a fairly high value can therefore be used, so that the shunt effect across the load is reduced. The capacitor ensures that there is no audio frequency feedback through this loop. Terminal 3 (11) provides a method of further adjusting the operation of the circuit for maximum gain while the feedback maintains the stability of the circuit, since any current fed in or drawn from it varies the voltage across R_1 (R_{12}), and the value of the resistor for this purpose, for best results, was 22 k Ω .

A.C. CONSIDERATIONS

The integrated circuit has other features which provide for audio frequency negative feedback, to maintain

COMPONENT VALUES

R_{13}	100 k Ω	C_1	4 μ F
R_{14}	100 k Ω	C_2	0.1 μ F
R_{15}	100 k Ω	C_3	0.1 μ F
R_{16}	4.7 k Ω	C_4	0.1 μ F
R_{17}	22 k Ω	C_5	30 μ F
R_{18}	1.2 k Ω	C_6	10 μ F
VR_1	5 k Ω	VR_4	10 k Ω
VR_2	100 k Ω	VR_5	10 k Ω
VR_3	100 k Ω		

Note.—Components R_1 - R_{12} and Tr1-Tr16 are part of the integrated circuit.

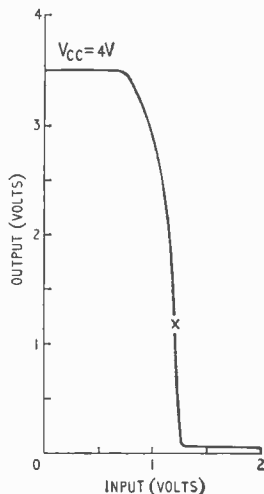

Fig. 3. Static electrical characteristics of i.c. alone. When R_{71} is added, the input and output voltage levels rise to a value nearer to $\frac{1}{2}V_{CC}$, and the gain therefore rises.

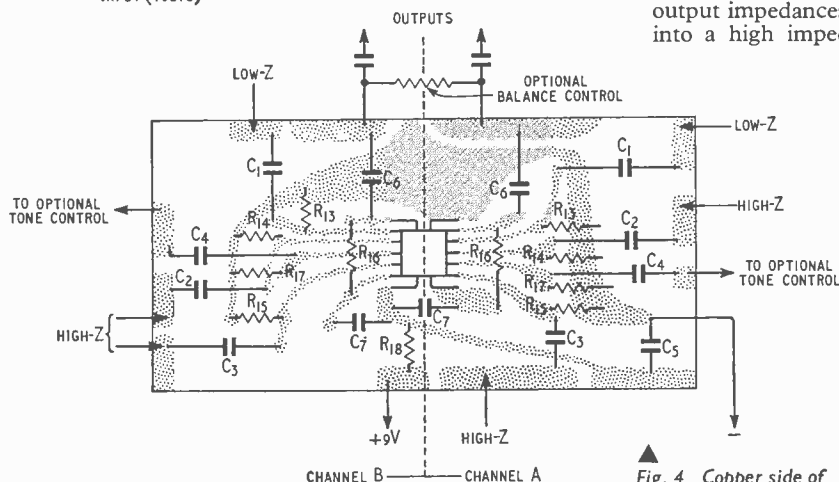

Fig. 4. Copper side of the printed circuit board. The integrated circuit is in the centre, held in position only by the leads soldered to the copper foil, and spaced from it by a plastic pad supplied with it.



Fig. 5. One of the writer's prototypes.

idelity and dynamic stability (for an uncontrolled oscillation would be equally as objectionable as a static instability which cut off or saturated transistors and prevented their functioning). Take Tr5 as an example. Its collector current flows through R_2 , and as far as this component of the current in R_2 is concerned, Tr5 is a common-emitter amplifier, so that it is out of phase with the signal as applied to the base. Therefore it opposes the signal developed across R_1 and R_2 by the emitter currents of the four p-n-p transistors. This reveals a further application of terminal 3. A capacitor to terminal 14 would selectively ground the higher frequency components of the signal, and if it is in series with a variable resistor such a capacitor would provide a useful measure of tone control, without in any way interfering with the function of the terminal in the d.c. stabilization system. As far as the rest of the amplifier is concerned, Tr5 is a common-collector (emitter-follower) stage, with its inherent negative feedback. Tr6, the phase splitter, has its emitter resistor unbypassed, so that a further element of negative feedback is involved. These facts were the basis of the expectation that this logic circuit would provide an audio performance which would compare favourably with apparatus designed for that purpose, even though the data available was insufficient for a rigorous mathematical analysis. However, proceeding on the approximations and assumptions already indicated, a prototype was evolved, and optimum performance then attained by experiment.

Fig. 2 illustrates the circuit of the pre-amplifier and component values are given in the table. It will be noted that two of the pairs of inputs differ from the third, in the values of coupling capacitor and volume controls used. The idea is to improve the matching between the signal sources and the amplifier in that devices with high output impedances will transfer the signal more efficiently into a high impedance input. Therefore smaller capacitors and much larger volume controls are advisable. The emitter follower type of input has a higher input impedance naturally, and in this case even this is improved on by the type of bias circuit employed, which, with a single high-value resistor, avoids loading the input. On the other hand, when an electrolytic coupling capacitor is incorporated, with a 5 k Ω volume control, the circuit accepts all low impedance sources, e.g. magnetic microphones, quite as well as any other transistor amplifier. The question of output matching was touched on in the discussion of the d.c. feedback system for static stability above. If the unit is to feed a valve amplifier, with its high input impedance, the balance pre-set should be a 50 k Ω linear type, again to avoid excessive loading of the circuit. However, for a transistor power amplifier, it will be found that the lower 5 k Ω value is better, since the loading is high anyway, and the smaller control is more suited to these conditions.

As for the details of construction (Figs. 4 & 5), the question of mounting this unit in the user's equipment is not considered, as it

As for the details of construction (Figs. 4 & 5), the question of mounting this unit in the user's equipment is not considered, as it

will depend so much on circumstances, and as the unit is so small and impedances generally are low, this is much less critical than with valve types. Construction begins with the preparation of the printed circuit board. Readers will, no doubt, be familiar with the process involved—the painting of the desired pattern of conductors on the copper foil laminated on a paxolin sheet, so that, when dry, these areas will be protected while the remainder is removed by the action of a concentrated solution of ferric chloride (FeCl_3). In this case, however, greater care than usual is required in the application of the resist paint, since the terminals of the 14-lead flat package are separated by a mere 0.034in from each other. Otherwise there is greater tolerance for deviation from the pattern shown, since there are no components employed with fixed pin spacings. Assembly follows standard procedure. The controls are not shown, and are placed to suit the constructor. Ganged potentiometers are used for all controls, with a preset balance control to compensate for any asymmetry in the performance of the pre-amplifier or power amplifier. The user may rely on the tone controls, if any, provided on his power amplifier, or extend the tone control of the pre-amplifier to suit his requirements. The pre-amplifier itself has only one set of components, which are frequency-selective (aside from any correction employed across $R_1 + R_2$ and $R_{12} + R_3$), and that is the input coupling capacitors. Otherwise, the response of the circuit is perfectly flat up to and beyond 50 kHz (Fig. 6). As for sensitivity, a prototype gave an output of 80 mV across a 2.5 k Ω load, when driven by a 1 kHz sine wave of ampli-

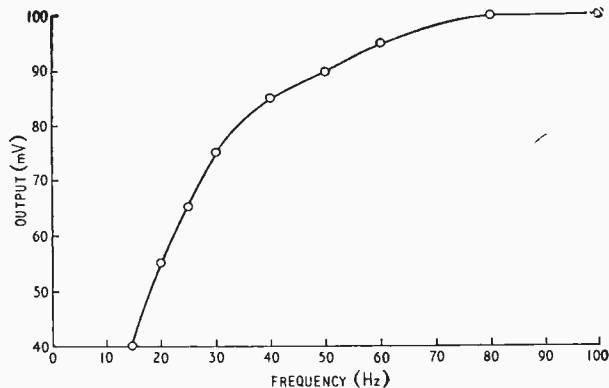

Fig. 6. Frequency response (tone control omitted). Beyond the range affected by the impedance of the input capacitor, output is constant up to at least 50kHz. Results above obtained with an Advance type H-1 audio oscillator, input 14mV, and output measured across a 2.5k Ω load.

tude 10 mV from an audio oscillator, all other inputs being short-circuited. Due to the quality control exercised in the manufacture of integrated circuits, the constructor can confidently expect similar results. For the writer at least, this circuit holds promise of even better things to come for the amateur in the field of integrated circuits; at the very least, the pessimism of a year ago is definitely no longer justified.

BOOKS RECEIVED

Servicing Transistor TV, by R. G. Middleton. A stage-by-stage description of typical modern transistor television receivers is given and faults peculiar to each stage and probable causes discussed. This book was originally written for the American reader and as a result American terminology is used throughout, however, an explanatory chapter is included for the English reader. Pp. 223. Price 30s. W. Foulsham & Co. Ltd., Slough, Bucks.

German/English Dictionary of Electrotechnology by E. Höhn. Meanings of German words as applied to the technical, legal, commercial and financial sides of the electronics industry are included in this dictionary. Multiple meanings are defined as are the differences between British and American usage. Pp. 705. Price 126s. Chapman & Hall Ltd., 11 New Fetter Lane, London E.C.4.

Feedback Circuit Analysis, by S. S. Hakim. After examining the classical approach to feedback theory a more generalized theory is developed based on circuit analysis by flow graphs. Stability problems in terms of closed loop transient response and open loop response in the real frequency domain are discussed. The theory of complex variables, stability and compensation of the forward and the feedback paths and the design of wideband amplifiers are dealt with in turn. Pp. 392. Price 95s. Iliffe Books Ltd., Dorset House, Stamford Street, London S.E.1.

Alternating Current Fundamentals, by Arthur P. Dillow. This book is intended to steer a middle course between a highly mathematical treatment of a.c. theory on the one hand and a simple explanation stripped of all mathematics (and therefore of little practical use) on the other. All the usual aspect of a.c. theory are discussed, i.e., magnetism, capacitance, inductance, transformers, etc. A chapter is also

included describing the various types of alternator. Pp. 416. Price 42s. W. Foulsham & Co. Ltd., Slough, Bucks.

Basic Principles of Electronics, Volume 1, Thermionics, by J. Jenkins and W. H. Jarvis. A knowledge of physics and calculus at sixth-form level is assumed in this book that commences with a discussion on the structure of matter, properties of crystals, thermionic emission and electron dynamics. The various types of vacuum and gas-filled valves and their uses in amplifiers, oscillators and measuring equipment are dealt with in some detail. Pp. 224. Price 21s. Pergamon Press, Headington Hill Hall, Oxford.

Dictionary of Radio & Television, by W. E. Pannett. New and well-established terms are listed in this dictionary including such technologies as sound radio, television, lasers, masers, semiconductor and thermionic devices, communication satellites, radio navigation, etc. In many cases extended definitions are given describing briefly the newer or more complex devices clarifying elementary and underlying principles of operation. The appendix deals with symbols, abbreviations, tables, colour codes, etc. Pp. 373. Price 36s. George Newnes Ltd., Tower House, Southampton Street, London W.C.2.

Integrated Electronics, by K. J. Dean, from the series "Modern Electrical Studies" aimed at assisting the engineer to keep abreast with modern technical developments. The book discusses the construction and limitations of integrated circuits in general, the emphasis being placed on digital rather than linear techniques; however, a section is devoted to linear amplifiers. A short glossary of some of the more unusual terms is included and the applications of integrated circuits are examined. Pp. 132. Price 28s. Chapman & Hall Ltd., 11 New Fetter Lane, London E.C.4.

RING-OF-TWO REFERENCE

High-stability voltage reference using constant-current circuit

By P. WILLIAMS, B.Sc.

Ring-of-two reference circuit described offers a simple means of providing highly stable reference voltages. There are two such references which can be identical or quite different. They are sufficiently insensitive to supply variations that for most purposes these can be ignored, giving additional freedom to the designer. Output resistance and temperature coefficient are almost exactly those of the same reference supplied from an external constant-current source. One version of the circuit uses transistor base-emitter junctions as Zener diodes.

IN the design of d.c. regulators, a prime requirement is a stable d.c. reference voltage. This is normally provided by a Zener diode chosen either for zero temperature coefficient or some specified coefficient that will compensate for a temperature drift occurring elsewhere in the regulator. For high stability against supply voltage changes, the Zener diode may be fed with current from a source which is itself stabilized. One common method is to derive the current from the output whose stability is ensured by that of the reference. Precautions have to be taken to "start" the circuit automatically since it might be possible for the Zener diode to receive no current initially, and hence develop no reference voltage. The output could stay at zero and in turn never provide current to drive the Zener diode into conduction.

A second method often employed is to feed the reference from another approximately stable voltage, such as a Zener diode with a higher breakdown voltage, but operated from the main supply. Thirdly, a transistor may be used to supply a constant current to the reference circuit by being biased, in turn, from a Zener diode. In addition to these arrangements, there is one which the writer has rarely seen used, but which combines many of

the merits of the above approaches. It can give extremely high rejection of supply variations; is economical of current; requires a supply voltage that need be little greater than that of the reference, or at most up to twice that value; is flexible enough to use Zener diodes of any breakdown voltage, and also other devices with suitable non-linearity of $V-I$ characteristics. From its appearance the writer has found "ring-of-two reference" to be a helpfully descriptive name for the circuit.

For the purposes of this article it may best be introduced by considering a combination of methods one and three outlined above. To improve further on the stability achieved in method three, it would be possible to cascade such complementary constant-current stages feeding Zener diodes indefinitely. After three or four such stages the limit would be reached in which only the output dynamic resistance in common base for the last transistor, would permit any change in current in the final reference. With a Zener diode of low slope resistance (a few tens of ohms at a current of milliamps) and an output resistance running into hundreds of kilohms, the stability factor will be extremely high. In such a case, temperature drift and noise are likely to be the dominant sources of instability and these will be primarily functions of the Zener diode itself. Thus a major merit of the system is that one can virtually ignore the effect of supply variation and select the final reference unit simply on the basis of required voltage and temperature performance. (This additional degree of freedom in design is often sufficient justification for this circuit.) The number of stages required to reach the maximum overall stability factor can be estimated by calculating the product of the stability factors of such stages, and stopping when this product is comparable with that imposed by the output resistance of the final transistor.

CIRCUIT PRINCIPLE

In the first method a comparable stability is achieved where the Zener diode receives its current from the output of a stabilizer for which it is itself providing the reference voltage. There are many cases where such a stabilizer



After graduating in physics at the University of Wales in 1958 Peter Williams, who is 29, was for two years an assistant master at a grammar school. From 1960-64 he was with the Mining Research Establishment of the National Coal Board at Isleworth where he was responsible for the design of electronic circuits for experimental mining machines. Since 1964 he has been a lecturer at Paisley College of Technology.

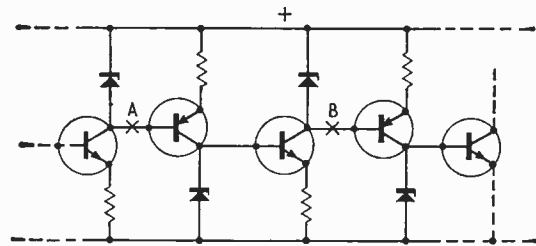

Fig. 1. Series of Zener diodes biased by constant-current stages. Each stage has better stability than the previous one.

is either not present in the system (e.g. where the reference is used to define the switching point in a level-sensing circuit) or where the output voltage is not sufficient to act as a source of bias for the reference. Now consider Fig. 1. By breaking the circuit at points A and B and joining them we use only two Zener diodes, two transistors and two resistors. The circuit then has total complementary symmetry of form, though not necessarily of component values. Assume that one Zener diode provides a constant potential at the base of its associated transistor, hence forcing a constant current to flow in the emitter resistor. The collector current is only slightly less, and so the other Zener diode receives a constant current in turn. In the same manner this ensures a constant current to operate the original Zener diode, with a consequent high stability, guaranteeing the validity of the original assumption. It can be seen that the stability of each Zener diode will be comparable to that of the last such diode in an indefinitely long chain of the type in Fig. 1. As indicated recently by Rudge,³ the stability factor might be expected to be of the order r_e/r_z where r_z is the slope resistance of the Zener diode at the operating point. The equivalent value for Fig. 2 might reach r_e/r_z in the limiting case of an infinitely long chain—though of course, three or four such stages should approximate to the ideal.

From the above it can be seen that the total current drawn by the circuit is substantially constant, since it is equal to the sum of the collector currents. Some recent correspondence^{1,2,3,4} has outlined the relevant characteristics of the circuit used as a constant-current source, and has shown how the circuit may be improved in respect of rejection of supply voltage variation³. In particular Mr. Baxandall has suggested a modified form which should provide almost perfect stability of current against variation of supply and temperature. The circuit used as a two-terminal device is a dual of the Zener diode, with greater flexibility in return for increased complexity.

TYPICAL APPLICATION

When used to provide an accurate voltage reference, the additional components required over the simple Zener diode circuit might seem a high price to pay. In many cases the remarkable improvement in stability factor is sufficient justification. If it is realized that the circuit has total complementary symmetry of form, the second major advantage can be brought out. There is a Zener diode tied to each side of the supply, i.e. we have two stable reference voltages, not one. It is at this point that the flexibility of the circuit must be indicated. Let us assume for the moment that the circuit is to be used to provide a reference voltage for a d.c. regulator, whose output voltage is too low to permit its use as the source of current for the Zener. In such a regulator the error amplifier may best be operated with a load of high slope resistance to obtain the maximum loop gain. This is frequently provided, as shown in Fig. 3, by a common base transistor stage. Using the ring-of-two reference a suitably stable bias voltage for such a stage is already available. A departure from symmetry of component values might well be of benefit in such an application. The Zener diode of Fig. 4 could be a selected unit of about 6 V breakdown, having the zero temperature coefficient. Provided the current through it is stable to about 1%, its stability should be extremely high (small changes of current will move it slightly away from its zero temperature coefficient point in addition to the direct change in output voltage produced). To achieve this accuracy of current definition, it will not be necessary to use a Zener

Fig. 2. Ring-of-two reference. Breaking at A and B in Fig. 1 and joining gives stability equivalent to infinite chain.

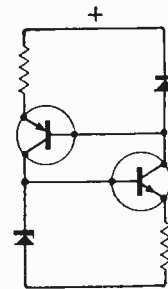

Fig. 3. Typical application requiring two reference voltages (high-stability d.c. voltage regulator). ▼

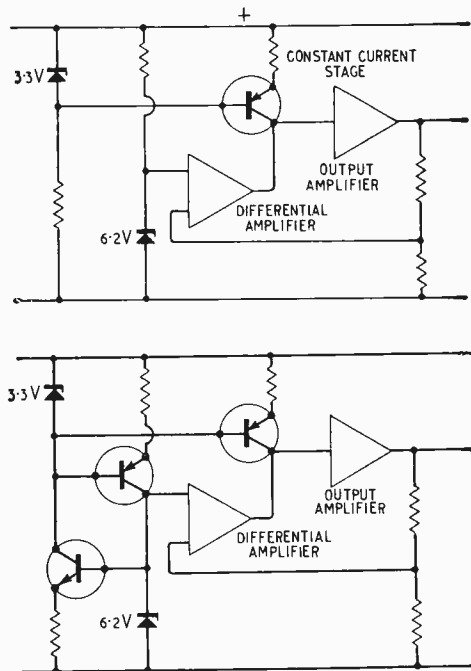

Fig. 4. Ring-of-two reference provides voltages with higher stability factors.

diode of comparable accuracy for the other diode. The change in transistor V_{BE} T_{r2} over a temperature range of, say 30 deg C, would be approximately -60 mV. Assuming this to be the major source of current drift with temperature—justified for high-gain low-leakage planar transistors—this would represent a current change of approximately 1% if a 6-V Zener diode of negligible temperature coefficient were being used. An alternative solution can be seen if the temperature drift of Zener diodes with breakdown voltages in the range 2.5 to 5 V is examined. A recent article³ has shown that for such diodes the drifts approximate to -2 mV/deg C though the tolerance is fairly broad. Using unselected Zener diodes of nominally 3.3 V breakdown at a current of 1 mA, the writer has found that the net temperature coefficient is often appreciably better than $\frac{1}{2}$ mV/deg C. This is equivalent, over a temperature range of 30 deg C, to an overall accuracy of better than $\pm 1\%$ for the resulting current.

LIMITS OF OPERATION

The stability of the reference diode is assured, but with it comes the added advantage that the temperature drift of the 3V diode is just that value to provide

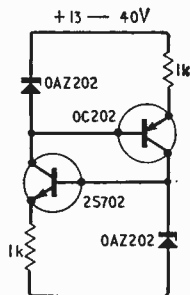

Fig. 5. Practical circuit using 6 V Zener diodes and operated at about 6 mA.

compensation for the V_{BE} drift on any transistor that is to be biased from it. In addition the total voltage required by the circuit is less than that required when using identical zero temperature-coefficient Zener diodes. With diodes of nominally 6.2 V and 3.3 V breakdown voltage the supply can be as low as 9 V without impairing stability. Two factors contribute to this low value: (a) operating the 3.3 V diode at say, 1 mA results in a voltage drop less than the nominal—in practice, perhaps 3 V, (b) the saturation voltage of the transistors may be about 0.2 V and the total voltage required to stay out of saturation can then be estimated as:

$$V_{Z2} + V_{C1sat} + (V_{Z1} - V_{BE1}) \approx 8.9 \text{ V.}$$

It should not be thought that taking wide tolerance components, the resulting minimum voltage can be held to this precise value. The figures merely illustrate that

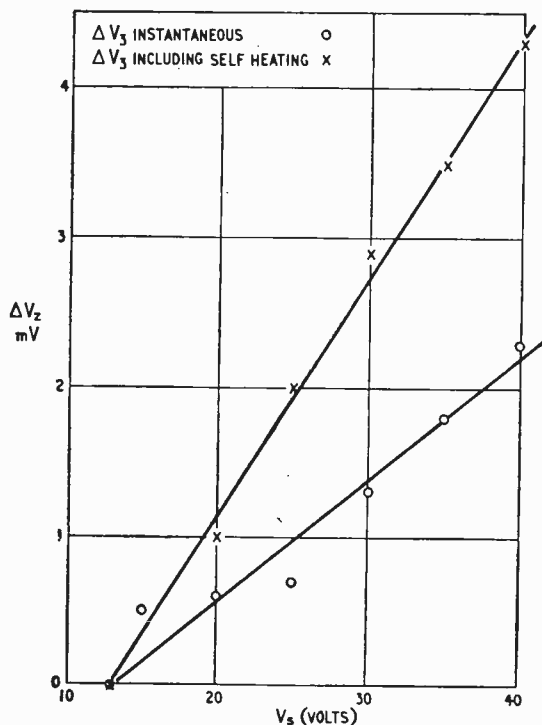

Fig. 6. Changes observed in V_z due to instantaneous change in V_s and resulting rise in temperature of transistors in circuit of Fig. 5.

the minimum voltage needed can be slightly less than the combined voltage drops across the Zener diodes. Silicon planar transistors are used unless otherwise specified with epitaxial units showing a further slight advantage in respect of saturation.

In the upper voltage limit of operation, the ring-of-two reference offers further advantages over conventional Zener diode circuits. In these the current drawn is proportional to the difference between the supply and Zener diode voltages. If the supply voltage doubles, the current will more than double, and the power drawn from the supply increased by more than four times. For example, if a 6-V Zener is operated over a supply range of 10 to 20 V, the current would be due to voltage drops across the series resistor from 4-14 V. The resulting range of power drawn from the supply would be 7 : 1. It is fair to argue that no reference circuit should be called on to operate over this range of supply voltages, and that a separate set of values should be calculated for each limited operating range. For the ring-of-two, the total current is constant throughout, and provided the transistors are operated within their power ratings, it can be used from any supply voltage up to the collector-base breakdown voltage of the transistors. The total power drawn from the supply is proportional to the supply voltage and not to its square. The upper limit can easily be above 50 V with suitable transistors, while the lower limit may be down to 5 V using low-voltage Zeners. Throughout this range, the current should be held to within one or two per cent and satisfactory Zener voltage stability maintained for a 10 : 1 change in supply voltage. Thus the same circuit can be used without change for many different applications requiring very different supply voltages. Design time can then be devoted to perfecting the basic circuit, e.g. the matching of temperature drifts, the whole circuit being treated as a building block in larger systems.

PRACTICAL CIRCUIT

A particular form of the circuit is now considered in which the aim is to provide two low temperature-coefficient voltages one with respect to each supply line. In the simplest case, and operating at low currents, the breakdown voltages will be in the region of 6 to 7 V. (For example, a typical alloy junction Zener diode of nominal breakdown voltage 6.8 V, had a drift of less than 10 mV over a temperature range 20-70 deg C with an operating current of 100 μ A. The voltage at this lower current level was approximately 6.5 V). At higher currents the voltage for zero temperature coefficient is less. The circuit is as shown in Fig. 5. Alloy junction Zener diodes have been commonly available, but their characteristics are not necessarily guaranteed at low currents. Accordingly the component values were chosen to ensure that each Zener diode is operating within its normal range. No difficulty was experienced in starting this particular experimental circuit, suggesting that the Zener diodes were low-leakage units, i.e. they would develop an appreciable voltage from the leakage currents supplied by the transistors, and initiates switching into the on state. The voltage drop across each diode is of the order of 6.5 V and hence the current in each emitter circuit is 6 mA, since the emitter resistor will see 0.6 V less—the V_{BE} of the transistor. Assuming high-gain transistors are used, the collector current is not substantially less, and so the current in each Zener diode is stabilized to about 6 mA. We may consider the circuit in isolation, since any load placed on either Zener diode will have almost the same effect as if the diode were

supplied from an independent constant current source, and hence may be simply calculated from the diode slope resistance. An increase in the supply voltage appears largely between collector and emitter of the transistors. There are two different but related ways in which the resulting changes produce an increase in current and hence in Zener diode voltages. The first, direct and instantaneous, is, as outlined above, related to the r_C of the transistors, if small signal analysis is used. Alternatively, the physical mechanisms can be invoked to account for the variations in h_{FE} , I_{CBO} and V_{BE} with increases in V_{CE} . The observed change in Zener diode voltage is seen in Fig. 6. The second effect stems from the additional power dissipated in the transistors, and its rate of appearance depends on their thermal time-constant. Their temperature will rise and the V_{BE} required to maintain an approximately constant current will fall. The change is of the order -2 mV/deg C and a dissipation close to transistor maximum might result in a change in V_{BE} of several hundred millivolts i.e. the current could change by two or three per cent in a short period, following the initial increase in supply. The two effects can only be distinguished by noting the initial change in Zener diode voltage, and then its final stable value some seconds, or even minutes, later. Both of these effects are extremely small in view of the large changes in supply, and the second can be made negligible if components are used that permit operation at much lower currents. Note that where both are included the stability factor is still in excess of 5,000.

The major source of change will thus be ambient temperature variations—directly on the Zener diode and indirectly *via* the small changes in current produced. These latter will be of the same order as the power induced changes described above, while the former are dependent on the individual Zener diodes. For this reason no separate measurements were made on the temperature performance of this version since the temperature-induced current changes would only be significant for reference units or others specially selected for very low temperature drift. Referring to Fig. 6 it can be seen that at a voltage level giving a dissipation of $\approx 150 \text{ mW}$ per transistor (and hence a junction temperature rise of many tens of degrees centigrade) the total change in Zener diode voltage was $\approx 4 \text{ mV}$. For unselected Zener diodes the effect would be masked by the much larger changes in voltage occurring as a direct function of temperature.

LOW-CURRENT VERSION: THE "ZENISTOR"

These results were obtained using the alloy junction diodes and transistors most easily obtainable at the time. Now that planar units are so easily obtainable a further version is possible that avoids one of the earlier limitations. The transistor leakage currents are of the order of nA rather than μA , and it proves possible to retain high gain at currents of a few μA . Similarly, a planar diode with a breakdown voltage of about 6 V will have a voltage across it little changed at currents of this order. Now the total dissipation in the transistors is much less than 1 mW, resulting in a junction temperature rise of less than 1 deg C. In this way the change in current attributable to self-heating is negligible and we are left only with voltage-induced changes. A 2 : 1 change in supply voltage can be expected to produce a change in Zener diode voltage of less than 1 mV—on one assumption: that the slope resistance of the diode has not increased too rapidly as the operating current falls.

To produce such a unit using planar Zener diodes

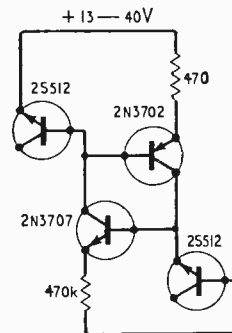

Fig. 7. Low-current version. Base-emitter junctions of planar transistors used in place of Zener diodes.

proved far too costly at the time the circuit was designed, and recourse was necessary to a technique which has some of the characteristics of a state secret—many people know something about it, but those who know most, say least. It concerns the use of transistors themselves as Zener diodes, and in particular the base-emitter diode operated with a reverse voltage. To obtain the desired transistor characteristics in regard to gain and frequency performance, the junction will be highly doped, and will have a low breakdown voltage. Since the transistor has to be used in circuits where it may receive appreciable reverse voltages, a compromise is struck as to the minimum value of this voltage. Manufacturers' data-sheets on planar transistors, usually quote a figure between 5 V and 8 V, though for some applications it may be higher. The breakdown is surprisingly consistent, at least within a given batch, and is certainly adequate where high stability rather than a particular value of

continued on next page

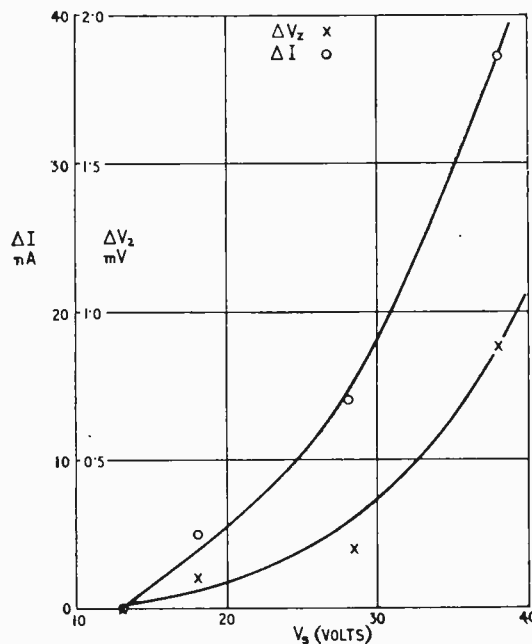

Fig. 8. Corresponding curves for Fig. 7 circuit. No significant heating effect at these low currents. At high voltages approach to breakdown causes current at voltage to increase more rapidly. $\Delta I \approx 0.1\%$, $\Delta V_z \approx 0.01\%$.

voltage is required. Among the transistors which have performed well in such applications are: C111, V205, 2S512, 2N3702, 2N3707, 2N2925, 2N2926 and BSY27. Breakdown voltages between 6 and 14 V have been observed for these transistors.

Perhaps it is not surprising that manufacturers of these transistors fail to stress that they can perform better, under certain circumstances, than Zener diodes several times more expensive. For higher voltages the collector-base breakdown bears investigation, and while the V_{EC} breakdown includes a negative resistance region, the addition of a forward-biased diode in series with the reversed biased V_{BE} can give some temperature compensation.

CIRCUIT CHARACTERISTICS

The circuit is shown in Fig. 7 and is identical in form to the previous one. For comparison it was decided to work at the same voltage levels but to reduce the current by a factor of about 500 to $25\mu\text{A}$ total. The "Zener diodes" were then the reverse-biased base-emitter junctions of two 2S512 transistors which had a voltage drop of $\approx 6.5\text{V}$ at this lower current. A 6 V drop across the resistors provides $\approx 12.5\mu\text{A}$ with resistance values of $470\text{ k}\Omega$. The transistors were types known to have high gain at these low currents. Voltage changes are measured by backing-off the "Zener diode" voltage against an external stabilized supply whose short-term stability was reliable to a fraction of a millivolt in 6 V. A digital voltmeter on its 20 mV range with a very high resistance was used to measure the difference. The change in voltage observed was of the same order as the noise present i.e. about 0.2 mV and further work will be needed to specify it with precision. The stability factor for each reference voltage (defined as $s = \Delta V_{in}/\Delta V_{out}$) is then about 100,000. It is fair to say that for most purposes the circuit provides reference voltages that are independent of the supply voltage, provided that this is greater than about 13 V. To confirm that the whole unit can be used as a constant-current diode if required, the current was measured in two indirect ways. First by measuring the voltage drop across each emitter resistor and noting the change with supply voltage— $\approx 5\text{ mV}$. And secondly, by placing a $220\text{ k}\Omega$ resistor in series and measuring the change in voltage across it—again $\approx 6\text{ mV}$. Both measurements indicate a change in current of about 25 nA in a total of $25\mu\text{A}$ for a supply range of 15-30 V. The current is thus stable to about 0.1%, though again temperature effects will be much greater. The reference voltage is stable to better than 0.01% over the same range, and possibly to 0.003%.

STARTING PROBLEMS

A final reservation is necessary about the general form of the circuit. In common with the first method outlined for ensuring that constant current through the reference, there is the possibility of the circuit remaining completely non-conducting. This is most likely where the leakage properties of the Zener diode, or equivalent, are worse than those of the transistors. Thus, for example, 3.3 V Zener diodes with their poor knee characteristics may require a starting resistor between the bases if used with planar silicon transistors, but probably not with germanium ones. The writer has found that the units described are consistently self-starting, even when the supply voltage is applied slowly and they have shown no tendency to switch-off. If this were not so, some care would be needed in the choice of starting and com-

pensating resistors to achieve anything like the same stability. No attempt has been made to compensate for the small existing drift in the circuits since it was comparable with the noise present.

REFERENCES

1. "Constant-current Circuit," P. Williams. *Wireless World*, Sept. 1966, p. 456.
2. "Constant-current Circuits," P. J. Baxandall, *Ibid*, Dec. 1966, p. 609.
3. "Constant-current Circuits," J. C. Rudge. *Ibid*, Dec. 1966, p. 610.
4. "Constant-current Circuits," P. Williams. *Ibid*, Jan. 1967, p. 37.
5. "Temperature Compensated Zener diodes today," J. McCoy. *Electronic Components*, Nov. 1966, p. 1030.

STEREO DECODER INPUT IMPEDANCE

IT has been brought to our attention that the input impedance of the stereo decoder design, published in the January 1967 issue, is not high enough for operation with certain tuners (e.g. Quad). In order to increase the input impedance Mr. Waddington suggests the use of an emitter follower as shown in the accompanying circuit and this necessitates removal of R_1 and R_2 . This results in an input impedance of greater than $100\text{ k}\Omega$.

Alternatively, R_2 may be removed and R_1 increased to about $470\text{ k}\Omega$. R_1 should be adjusted so that the voltage at the emitter is 3-V. This method is likely to be more temperature sensitive than the first, particularly in the case of the p-n-p version when Tr1 is germanium.

In connection with the decoder design attention is drawn to the corrections which were pointed out in the February issue. The reference to the limiting figure of 60mV should be read as 6mV. In Fig. 9 the centre top of T3 secondary should be taken to earth and C_{11} connected to Tr6 emitter. Further, for the positive earth version, diodes D1 and D2 (Fig. 9) should be reversed.

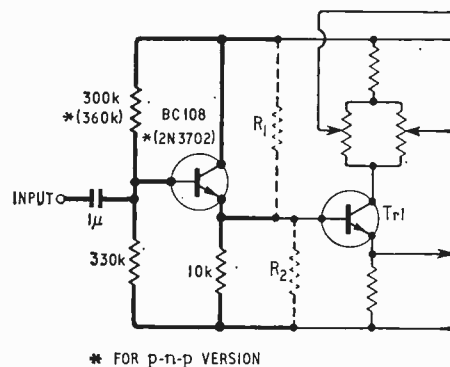

Montreux Television Symposium and Exhibition

THE exhibition which forms an integral part of the biennial Montreux Television Symposium was this year (May 22nd-26th) so much larger and more comprehensive that many delegates were asking "will it become the European equivalent of the American N.A.B. Show?" The forthcoming International Broadcasting Convention and exhibition to be held in London in September (20th-22nd) is seen in this role by the organizers—the Electronic Engineering Association, I.E.E., and Royal Television Society—but one wonders whether the Montreux gathering has not already established itself in this position. Time will tell. Certainly, never before in Europe have so many different colour cameras and associated equipment been working in the same place. There were eight different types of camera from six manufacturers—Marconi, C.S.F., G.E., Thomson-Houston-Hotchkiss-Brandt (who have a reciprocal agreement with E.M.I. on colour cameras), Fernseh, and Philips—all of which were being demonstrated both under studio lighting conditions and also outside the Casino where the exhibition and symposium were held. Visitors had the opportunity of seeing both the original scene and that displayed on the large number of monitors. There is, of course, some degradation of colour and on the Fernseh stand small slides of tinted glass were provided which, when held so that the scene was viewed through it, provided the necessary colour temperature correction and one could then see how faithfully the colours were reproduced. Incidentally, Philips were bold enough to include in their "scene" a variety of lipsticks and the subtle differences in colour were faithfully reproduced.

As might have been expected the two schools of thought on colour cameras—whether or not a fourth tube should be used for luminance—were being hotly debated among participants, but one was disappointed in that, other than presenting formal papers on the two philosophies, there was no direct clash between proponents. Philips did, however, issue a formal statement towards the end of the conference stating categorically that they had "firmly decided in favour of the three-tube principle." They gave as their main reason the fact that once all the cameras in a studio are adjusted on a monochrome chart "perfect colour matching is ensured" when switching from one camera to another, and secondly that because of the low scattering losses due to the compactness of the tri-prismatic system the three-tube camera can work at illumination levels down to 250 lux.

The symposium opened with reports outlining the progress in television in France, Germany, Italy, Japan, U.S.A., and U.S.S.R., but not the U.K. Why is it the broadcasting authorities in this country are so tardy in making known the contributions of U.K. engineers or was it that they were keeping their reports for the forthcoming London convention? There were, nonetheless, several British papers presented. They included "Camera tubes and the requirements of colour" W. E. Turk (E.E.V.); "Distribution and broad-

cast by satellites" G. K. C. Pardoe (Hawker Siddeley Dynamics); "Wired broadcasting by the h.f. multi-pair method" G. P. Gabriel (Rediffusion); "A practical embodiment of the separate luminance principle" I. J. P. James (E.M.I.); "Colour fidelity in a four-tube colour camera" N. N. Parker-Smith (Marconi); "A dual-purpose monochrome photoconductive camera" J. D. Capers (Marconi); and "International aspects of educational television" Dr. A. Ward (Glasgow University).

Some idea of the interest in the symposium—or was it the venue?—can be gained from the number of registered participants; over 400 from 28 countries. As would be expected, the largest number (88) was from Switzerland, next Germany (73), the U.K. (53) and France (43). But, of the 32 exhibitors 10 were from the U.K., six from both Switzerland and the U.S.A. and four from France.

Although colour was the dominant note of the exhibition there were many other aspects of television which were dealt with by contributors to the symposium. Three papers were devoted to the question of broadcasting from satellites. Mr. A. Iorillo, of Hughes Aircraft, said "The next generation of Clarke's concept [W.W. October, 1945] is the realization of domestic satellites." Although the American Broadcasting Company's application for its own satellite had been turned down by the F.C.C. he foresaw a domestic satellite television system in the U.S.A. in a few years. It would have a multiple beam aerial system providing individual services for the different time zones. Mr. Pardoe (Hawker Siddeley) in his paper dealt first with the use of satellites for the distribution of television. He referred to the studies now being conducted by Eurovision, Eurospace, the European Conference for Telecommunication Satellites (C.E.T.S.) and the Conference of European Postal & Telecommunication Administrations (C.E.P.T.) regarding a European regional telecommunication system, including television distribution, and the methods by which it can be met. He then went on to discuss direct broadcasting by satellite "the obvious advantage of which is the high level of coverage that can be obtained compared with any extension to the existing terrestrial system." Mr. Pardoe said "The question is not if, but when, these facilities can become operational." However, Dr. Nestel of Germany put five pertinent questions in his paper which followed:—Have you a frequency? a missile? the money? the programme? a transmission standard?

Although both the symposium and the exhibition were mainly concerned with the origination, recording and transmission of television there were several papers dealing with aspects of distribution and reception and also special applications of television in, for instance, education and medicine. Incidentally, one of the highlights was a live Ediphor colour demonstration which included ophthalmic manipulations and microscope investigations of plankton. On the receiving side considerable interest was created by the two-gun Jatron colour tube described by W. Jaeger of Florence.

WORLD OF WIRELESS

High Resolution Radar for London Airport

A NEW radar installation is undergoing trials at London Airport; it is the Airfield Surface Movement Indicator Mk. 3 that has been developed by Decca Radar. A.S.M.I. is a high resolution radar that presents the local air traffic controller with a visual display of all movements of aircraft and vehicles on the airfield; it is thought that this equipment will be invaluable when blind landing in poor visibility is in widespread use. For once the aircraft has landed it is still necessary to guide it to the dispersal point; however, with this system the controller can be certain that there are no aircraft or service vehicle obstructing the taxi track at any point.

With such a system it is essential that the movement of objects appear to be continuous and not a blip on a high persistence screen as was the case with the Mk. 1 version. To achieve this with the minimum of flicker the aerial, which consists of an inverted cosecant squared reflector, is made to rotate at 750 r.p.m. and is driven by a hydraulic motor to prevent the noise pick-up that could

occur if an electric motor was used, the actual weight of the rotating head is 200 lb.

The equipment operates in the Q band at 35 Gc/s, pulses have a reduction of 30 ms and a peak power of 12 kW; the p.r.f. is 15 kc/s. An overmoded X-band waveguide is used to couple the transmitter to the aerial, preventing losses that would occur if a Q-band waveguide was used; this enables the aerial to be mounted remotely from the transmitter. With the exception of the later stages of the modulator, transistors are used throughout the equipment.

A 12 in p.p.i. display that has four switchable range scales 0.5, 1.0, 1.5 and 2.5 nautical miles, is used. The display can be off-centred, thereby increasing the range in any particular direction. An internal preset control enables the whole picture to be rotated.

The performance of the system is such that it is possible to see the housings of the flare path lights, which project only a couple of inches above the runway surface; it is also possible to identify most aircraft types.

Colour Television in Europe — the Latest Situation

ACCORDING to information given at a recent meeting of the E.B.U. Technical Committee in Amsterdam, the dates for the commencement this year of colour television broadcasting on a regular basis in the countries of continental Europe are as follows. France will include regular colour programmes in the O.R.T.F.'s second television programme (625 lines u.h.f.) from 1st October. In Germany both the A.R.D. (Federal Republic) and the Z.D.F. (Democratic Republic) will start officially on 25th August in the v.h.f. and u.h.f. bands. Colour will be included in both the first (v.h.f.) and second (u.h.f.) programmes of the Netherlands from 21st September, although formally it will not open until the 1st January 1968 with a weekly eight hour service.

Information received from Austria states that colour trans-

missions due to start in the autumn have had to be postponed because of high costs, but no new starting date has been given. The situation in Italy is much the same; for although R.A.I. has made a number of colour programmes, the government has decided to postpone colour television until 1970, on economic grounds. In Switzerland the reception of French SECAM and German PAL programmes will be possible depending upon the location of the receivers, but the Swiss Post Office and television networks will not start regular programmes until 1968. It is also understood that in the U.S.S.R. test transmissions of the joint Soviet-French Secam colour system will start in October, but no definite date for the start of a regular service has yet been announced.

New Space Science Laboratory Opened

HOLMBURY HOUSE, near Dorking, Surrey, is the home of the Mullard Space Science Laboratory, which although officially opened on 3rd May, has been in full use since last October. These premises were purchased by University College, London, through an endowment of £65,000 from Mullard Ltd., for housing the laboratory which is part of the Department of Physics and is in fact the largest scientific space research centre in Britain, carrying out 25% of the total space research in British universities. At Holmbury there are six laboratories used by 23 scientists, and seven research students.

The origins of space research in Britain can be traced back to a letter in *Nature*, April 7th, 1956, entitled "Rocket Exploration of the Upper Atmosphere" signed jointly by Sir Harrie Massey, Quain Professor and head of the Department of Physics at University College, and Dr. F. E. Jones, now managing director of Mullard Ltd. Over the past ten years, research has progressed from ionospheric studies conducted with sounding rockets, to more sophisticated study programmes involving earth satellites, topside sounders, and a great deal of co-operation between U.C.L., N.A.S.A. and D.S.I.R.

The present work of the laboratory concerns experiments on eight satellites, and over thirty sounding rockets. Investigations will include fresh work on ultra-violet and X-ray astronomy of the sun and other bodies. Ionospheric studies will continue to have the greater proportion of individual

experiments. The actual practical work in Holmbury House is of a purely scientific nature since it is concerned mainly with originating new measurement methods, and the calibration of experiments before flight. Advanced projects now being prepared include a combined telescope-spectrometer to be launched in a star-pointing rocket for u.v. spectroscopy, and an experiment measuring the distribution on the solar disc of sources of intense chromospheric and coronal emission lines. Full liaison is being maintained with other space programmes at British universities such as Imperial College, and Southampton University, as well as with international bodies such as E.S.R.O. (European Space Research Organisation) and N.A.S.A., previously mentioned.

Stockholm

Telecommunications Tower

THE 459-ft high, angular concrete tower stands in Kaknä, in the north-east of Stockholm. Constructed for the Swedish Telecommunications Administration, and officially opened on May 12th, it functions as a broadcast control centre, where selection, switching and supervision of sound and television circuits are carried out. Television and sound

material from the Stockholm studios of the Swedish Broadcasting Corporation, and programmes originating in the provinces or from abroad, will all be relayed from this tower. Remote control of a large number of transmitters and radio-relay stations will also be effected, and there are 10 facilities for the operation of multiplex telephony services. The tower is 32 ft square, and the figure 3 in the photograph indicates the position of the power supply control plant which includes emergency generators and standby batteries, as well as power supply apparatus for battery fed telecommunication equipment. The five levels indicated by 10, house radio-relay equipment for sound television broadcasting, and for multi-channel telephony; parabolic aerials for the radio-relay links will be placed in balconies on four of these levels. The 52-ft steel lattice tower will take radio-link aerials for special purposes, and it is provided with fixed and rotating flight warning lights. Equipment is already installed for the possible future distribution of colour television. Other services within the tower include testing and repairing of radio equipment at 7, and air conditioning and moistening plant for the proper functioning of equipment at 2. Overall cost was over £2M.

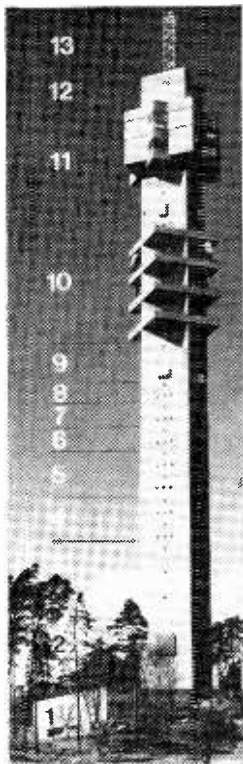

Advancement in Metrology

THE awareness in this country of the need to develop the science of measurement, and to improve its academic status is demonstrated by the recent endowment of a Chair of Electrical Metrology by the Wayne Kerr Company at the new University of Surrey (formerly the Battersea Polytechnic), and a grant of £27,000 from the Ministry of Technology to the University. This latter takes the form of a three-year contract for research into measurement standards in the radio frequency field. When announcing this contract, Mr. Edmund Dell, Joint Parliamentary Secretary, Ministry of Technology, said, "We must develop the nexus between industry and university. Industry in the end pays for the university, and the university should supply industry both with people and knowledge. Yet there seems to be a very different relationship in this country between university and industry from that which exists in the U.S.A." The strength of many American seats of learning is that manufacturers' research facilities are built on the periphery of the campus, providing a wonderful opportunity for cross fertilization.

More specifically, this contract will involve the Wayne Kerr Company, the Royal Aircraft Establishment, the National Physical Laboratory, and the Ministry of Technology. The University will produce means of facilitating the measurement of transistors and integrated circuits, working at frequencies in the order of 100 Mc/s. This embraces the development of a standard design of test equipment, standards of impedance, and techniques for connecting the test equipment to the circuit or component being measured. Among the benefits expected from this programme is a substantial contribution to the development of a calibration service, commercial applications of these new techniques, the opportunity for Surrey University to develop as a centre in this specialized field, and for both the R.A.E. and N.P.L. to advance their own work programmes as a result of the techniques and tools developed.

World Radio Club is the name of a new weekly, quarter-hour programme for short-wave enthusiasts to be broadcast in the B.B.C.'s World Service. It will be transmitted at 0745 G.M.T. each Saturday morning, beginning on 1st July. The programme content will be news and comment on broadcasting and receiving, technical talks, advance information on listening conditions and DX news. Membership of this club is obtainable on request from World Radio Club, B.B.C., Bush House, London W.C.2, and questions and comments are invited from members. The programme will be broadcast again on Sundays (0245), Tuesdays (2100), and Thursdays (1245) in all the short-wave bands and also on 211 metres.

Belling & Lee have stated that they are prepared to champion the right of any tenant to enjoy a satisfactory colour television picture. In detail, they are prepared to take up the case of any tenant in negotiation with his landlord for an outdoor u.h.f. aerial, in view of the fact that satisfactory colour television depends to a large extent on suitable aerials being accurately installed. If necessary, the offer has been made to finance a test case. Simultaneously, Belling & Lee announce that u.h.f. set top aerials will no longer be made. A ten-element outdoor or loft aerial is recommended, "in order to give the introduction of colour television, the maximum chance of success."

The schedule of BBC-2 colour trade tests was revised on June 5th, and transmissions are now radiated each weekday from 0900 to 1200, 1200 to 1300 (except Mondays) and 1400 to 1915 when a colour film will be transmitted. The sequence of tests consists of the monochrome test card, colour bars and colour slides accompanied by a 440 c/s tone or recorded music, and an occasional film.

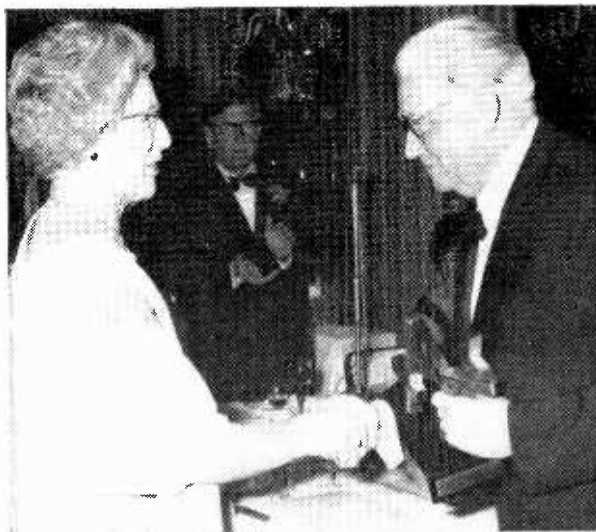

The Geoffrey Parr Award of the Royal Television Society, which is presented annually to either an individual or a team in recognition of a contribution to television engineering or an associated science, has been given to Dr. Walter Bruch and his team for their work on the PAL colour television system. It was presented at the Society's annual dinner on May 19th by Mrs. F. E. Parr and received on their behalf by Dr. Carl Zickerman, general manager, research and development service department of AEG-Telefunken.

PERSONALITIES

N. R. Bell, B.Sc.(Eng.), M.I.E.E., has been appointed to the new post of chief design engineer (measurement standards) at Marconi Instruments. He joined Marconi Instruments in 1953 and in 1961 was appointed a group leader responsible for a number of proprietary instrumentation projects. Latterly he



N. R. Bell

has been mainly concerned with oscilloscope design and development. **B. A. Murphy**, senior measurement standards engineer, will continue in charge of the Standards Laboratory at St. Albans.

At each of the biennial International Television Symposia held in Montreux presentations are made to several distinguished television engineers in recognition of their "outstanding contributions and leadership." At this year's Symposium (May 22-26) Dr. W. Gerber, of the Swiss P.T.T., who was chairman, presented scrolls to **Georges Hansen** (E.B.U.), **Dr. M. I. Krivosheev** (Radio Research Inst., Moscow), **Dr. R. D. A. Maurice** (B.B.C.) and **Professor V. Siforov** (Popov Society, Moscow). Mr. Hansen, who is 58, is director of the Technical Centre of the European Broadcasting Union in Brussels which he joined in 1956. He has been secretary of the Union's *ad hoc* group on colour television since it was formed in 1962. Prior to joining the E.B.U. he was with the Belgian Broadcasting Corporation from 1936 (except for the war years) and became chief engineer and deputy director general. Dr. Krivosheev, who is 45, worked in the Moscow Television Centre after graduating and was later in charge of the Television Department of the U.S.S.R. Ministry of Telecommunications. Since 1959 he has headed the television department and the laboratory for television measurement of the Radio Research Institute. He obtained his doctorate in technical sciences in 1966. Dr. Krivosheev is deputy chairman of the television study group of the International Radio and Television Organiza-

tion (O.I.R.T.) which is the Eastern European counterpart of the E.B.U. Dr. Maurice, who received his Doctorat d'Ingenieur from the Sorbonne, Paris, in 1952, has been with the B.B.C. since 1939 having previously spent six years with E.M.I. Dr. Maurice, who is 55, has been in the Research Department throughout his career with the B.B.C. He was appointed head of the television group in 1958 and has been assistant head of the department since 1961. Professor Siforov, who is 63, received his doctorate of technical sciences from Leningrad University where he was appointed professor of radioelectricity in 1938. In 1953 he became corresponding member of the U.S.S.R. Academy of Sciences. Since 1954 Professor Siforov has been president of the Popov Society of Radiotechniques.

Professor J. E. Flood, D.Sc., Ph.D., F.I.E.E., who has occupied the chair of light current electrical engineering at the University of Aston, Birmingham, for the past two years, has been appointed head of the Department of Electrical Engineering. Dr. Flood, a graduate of Queen Mary College, University of London, was chief engineer in the Advanced Development Laboratories of A.E.I.'s Telecommunications Division prior to entering the academic world in 1965. While at A.E.I. he was closely associated with the development of electronic telephone exchanges and was a member of the Electronic Research Committee set up by the Post Office and telephone equipment manufacturers.

Air Cdre. K. B. S. Wilder, C.B.E., B.Sc., M.I.E.E., who is 49 and has been director of telecommunications at the Air Ministry since 1963, is appointed air officer in charge of engineering, R.A.F., Germany. A graduate of University College, Nottingham, he was commissioned in the R.A.F. in 1940 and during part of World War II was at the Air Ministry on telecommunications and radar duties. He has served as H.Q. signals officer in several operational areas and in 1962 was appointed command electronics officer, Far East Air Force.

J. H. Leck, M.Eng., Ph.D., M.I.E.E., who graduated at the University of Liverpool in 1945 and has been on the staff since 1950 (latterly as reader in electronic engineering) is the first incumbent of the new chair of physical electronics at the University. Professor Leck, who is 42, was in the research department of Metropolitan Vickers from 1946 to 1950. He has recently been at Washington State University as senior foreign visiting fellow.

F. J. Balston has been appointed resident engineer at the B.B.C.'s Atlantic Relay Station, Ascension Island, in succession to **J. M. Rowe** who completes his tour of duty in August. Mr. Balston joined the Corporation in 1943 and served at several transmitting stations until his transfer in 1956 to the Woofferton, Shropshire, short-wave station where he has been assistant engineer-in-charge since 1960.

Edward Milton (right) receiving the 1967 John Logie Baird Travelling Scholarship (value £200) from Mr. J. C. O'Regan, of the Baird Company which donates the award, at the Royal Television Society annual dinner. Mr. Milton, who obtained a B.A. degree in electrical engineering at University College, Cork, Ireland, has been in the Experimental & Development Department of the I.T.A. since 1964. He is at present engaged on a two-year part-time M.Sc. course in physical electronics.

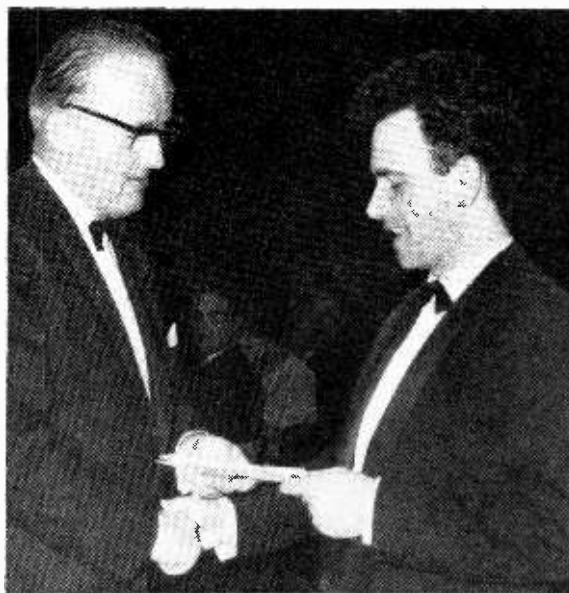

David R. A. Steadman, B.Sc.(Eng.), who joined the Marconi Company as a student apprentice in 1955, has become marketing manager of the company's Radio Communications Division. After spending four years as an apprentice he was given leave of absence to attend London University, where he took an honours degree in engineering.



D. R. A. Steadman

In 1960 Mr. Steadman returned to the Company to do a year's postgraduate course at Marconi College. He then joined the sales department of Communications Division. In 1964 he spent a year with the Company's International Division as resident regional manager, Far East Office, in Singapore. Mr. Steadman returned to the Radio Communications Division and for the past year has been regional sales controller (Africa).

Cyril Smith, B.Sc.(Eng.), A.M.I.E.E., has been appointed managing director of Radyne Ltd., of Wokingham. Mr. Smith was previously general divisional manager of the dielectric and magnetic, and the capacitor divisions of the Plessey Company, based at Towcester. He trained in telecommunications with the G.P.O. and during World War II served in the Royal Signals, retiring as a Captain. He joined Sir William Penney's team at Fort Halsted, near Sevenoaks, in 1950 and later was superintendent in charge of electronic production, Atomic Weapons Research Establishment, Woolwich Common. He joined the Plessey Company in 1960. **E. C. Stanley** and **C. E. Tibbs**, founders and former joint managing directors of Radyne, now a subsidiary of the David Brown Corporation, will continue to be associated with the company as directors.

Eric Willis Jones is appointed chairman and **Jack Shields, B.Sc., Ph.D., M.I.E.E.**, managing director of AEI-Thorn Semiconductors Ltd., the new company, formed to combine the semiconductor interests of AEI and Thorn, which is to operate as part of the Components Group at Lincoln. Mr. Willis Jones was commercial manager and later general manager of AEI Semiconductors. Since December last year

he has been general manager of the AEI Components operation, a post he will continue to hold in addition to his new responsibilities. He is also chairman of the VASCA Semiconductor Division. Dr. Shields led the development of microelectronics at the AEI Central Research Laboratory, Rugby, until his appointment, in 1964, as the chief engineer, AEI Semiconductors.

George H. Doust, director of the Plessey Company's Australia Group for the past two years, has returned to the U.K. to take up the post of director of the Plessey Components Group. Mr. Doust, who is 50, joined the company in 1956, and before going to Australia was managing director of Plessey International Ltd. and sales director of Plessey UK Ltd. His successor in Australia is **Robert Hall**, at present general manager of the Plessey Components Group's three mechanical divisions at Swindon.

A. F. Burke, M.B.E., has been appointed by the International Telecommunications Union as adviser on telecommunications and planning engineer to the Ministry of the Interior, Kuwait. During the war he served as a Signals Officer in the Navy and commanded the Brussels and Hamburg Naval Signal Centres. He has since



A. F. Burke

served as Force Signals officer to the Police Forces of Tanganyika, Cyprus, Uganda and Fiji.

Arthur F. Dyson, Grad.I.E.E., Grad. I.E.R.E., has been appointed engineering director of Eric Resistor Ltd. with special responsibility for product and engineering development. His early experience was with A.E.I. where he undertook a five-year course of training in electrical engineering followed by three years' research work. From 1961 to 1963 he worked in the U.S.A. with Eric Resistor's parent company in Pennsylvania, and since 1963 he has been with Eric in this country. Mr. Dyson, who is 34, is the elder son of the chairman and managing director of Eric Resistor Ltd.

D. R. W. Thomas, M.B.E., M.I.E.E., has been appointed chief engineer of the Data Systems Division of Standard Telephones & Cables in succession to **Dr. G. G. Smith**, who has been seconded to British Overseas Airways Corporation. Mr. Thomas joins S.T.C. from the Ministry of Defence. He served with the Royal Corps of Signals from



D. R. W. Thomas

1942, and latterly as a General Staff officer in the Ministry of Defence. **F. W. Simpson** is appointed assistant chief engineer of the S.T.C. Data Systems Division. He has transferred from Standard Telecommunication Laboratories at Harlow, where he has been in charge of projects dealing with the reliability and dependability of digital electronic equipment, computers and satellite communication equipment.

OBITUARY

Alfred Harold Whiteley, M.B.E., managing director of Whiteley Electrical Radio Company, of Mansfield, Notts, which he founded in 1926, died suddenly in London on May 23rd while visiting the Components Exhibition. Mr. Whiteley, who was 74, was also joint founder and governing director of Marrison and Catherall the permanent magnet manufacturers. In 1949 he was elected a companion of the Institution of Electronic & Radio Engineers and has served for some years on the council.

John Arminson Rouse, general manager and secretary of the Radio Society of Great Britain, died suddenly at his home near Guildford, Surrey, on May 26th, aged 46. Mr. Rouse held an artificial aerial licence (2AHL) prior to World War II and obtained a full transmitting licence (G2AHL) in 1946, after operating from India as VU2HL while serving in Royal Signals. He was keenly interested in v.h.f. and mobile work. He joined the R.S.G.B. in 1952 as assistant editor and became editor ten years later. He was appointed general manager and secretary on the retirement of John Clarricoats, O.B.E. (G6CL) at the end of 1963.

Thyristor Speed Control for Electric Drill Motors

Governor using motor back-e.m.f. as regulating voltage

By K. C. JOHNSON, M.A.

THE advent of the thyristor has opened up the possibility of making compact and efficient electronic controllers for equipment powered directly from the mains electricity supply. One application for them that will be of interest to readers is the regulation of the running speed of ordinary small electric drills. These tools normally contain a simple series-wound commutator motor that drives the chuck through reduction gearing. Sometimes the gear ratio is adjustable, but there is no form of governor to prevent the speed from rising and falling with every change of load. The addition of such a governor can extend the usefulness of the drill not only for drilling masonry or other materials which require a low cutting speed, but also for a variety of different jobs, winding coils for example, for which the use of an ungoverned drill would never be considered.

Electrical measurements on a typical drill show that when stationary the motor has a resistance of $45\ \Omega$ and an inductance of $0.5\ \text{H}$. At mains frequency this means a minimum impedance of about $160\ \Omega$ at a phase angle of near 75° . In normal usage the motor spins and the drill then presents a higher impedance than this to the mains, but it is important to notice that even under stall conditions the peak current is unlikely to exceed perhaps $3\ \text{A}$.

The iron laminations which are used to make the field in such a motor have an appreciable amount of magnetic hysteresis. This means that a remanent magnetic field is left when the motor current falls to zero, and measurement shows that this is sufficient for an e.m.f. of about $7\ \text{V}$ to be generated when the drill is spinning near maximum speed but has no current flowing through it. Naturally this voltage appears in such a direction as to oppose the last large current that was passed through the motor. Further measurement shows that a current of $100\ \text{mA}$ or more must flow before this remanent magnetism is seriously disturbed, but that smaller currents can add or subtract from the remanent field without having any permanent effect. A current of $5\ \text{mA}$ will, in fact, cause a change of about 10% in the remanent field and hence in this generated voltage.

It is this remanent generated voltage which is to be used in the controller to be described as a measure of the drill speed. A thyristor in series with the motor will be fired at the appropriate phase-angle of the mains so as to regulate the power delivered and maintain the motor speed at a desired value. If the drill slows down the firing angle will be advanced so that more power is delivered, while if it speeds up the power will be decreased.

The thyristor used (s.c.r.) must be capable of carrying the full centre-to-peak mains voltage, so that a device

rated for $400\ \text{V}$ is advisable. It must also carry the peak current when the drill stalls, so that a $3\ \text{A}$ rating is necessary, and an adequate heat sink must be provided. Lastly the thyristor must fire reliably from a trigger current of $20\ \text{mA}$. Many manufacturers offer types that meet these requirements; in the STC range, for example, the appropriate device is CRS3/40AF.

It will be seen from the diagram that this thyristor is connected directly between the "live" wire at the mains input and the output socket into which the drill is plugged without its having to be modified in any way. The use of this simple arrangement does indeed mean that the drill can receive voltage only during the positive half-cycles of the mains, but it is surprising how little difference this makes to the power available. A full-wave arrangement would have to be much more complex and expensive for comparatively little advantage. Note that with this circuit a switch connecting the input L direct to the output L can be added, so that ungoverned full power is quickly obtainable without any worry about the small currents that flow in the resistors which remain connected across the high voltage. Similarly no harm results from switching off at the drill itself, when this is more convenient, for the same reason.

For safety a fuse, set initially as low as $1\ \text{A}$ but perhaps increased to $3\ \text{A}$ if failure occurs under legitimate loading, is included at the input terminal. Again for safety it must be remembered that this circuit contains parts at the full mains voltage and it is absolutely essential that these must be fully protected before the device is put into everyday use as part of an electric drill. A feature of the circuit is that large voltages are not applied to the control potentiometer, but even so it should have its spindle earthed in the proper way.

CIRCUIT OPERATION

Consider the group of components at the right hand side of the circuit diagram. The $1\ \text{k}\Omega$ resistor here serves purely to limit the surge current when the thyristor fires, but the diode and capacitors form a low-voltage power supply. At peak negative mains voltage the diode conducts preventing any significant reverse voltage on the capacitor across it. As the mains rises from negative towards zero, current from the $0.05\ \mu\text{F}$ capacitor charges up to the $2\ \mu\text{F}$ capacitor, which can be an electrolytic type, to about $8\ \text{V}$ and a voltage of at least this magnitude will then be available throughout the positive half-cycle if no current is taken by the transistors. Notice that if power is used the only effect is that the diode conducts sooner than would otherwise have been necessary; the available voltage in the following cycle is unaffected.

WORLD OF AMATEUR RADIO

Phone-only Licences in the Netherlands

IT has been the practice in the Netherlands since 1955 to issue licences for operation on 144 Mc/s and above to amateurs who pass a technical examination but not a Morse test. Statistical information published in the April number of I.A.R.U. Region I Bulletin discloses that the number of such new licences issued each year now exceeds the number of general licences. The figures for the past six years are:—

	Number of New Licences	
	General	Phone only
1961	32	67
1962	34	92
1963	20	74
1964	24	86
1965	27	85
1966	21	98

Last year the number of phone-only licences in force in the Netherlands represented one-third the full total. If the present trend continues a situation may well arise in the near future when the number of such licences will exceed the number of general licences. In the United Kingdom phone-only licences are granted for work on 420 Mc/s and above, and holders are identified by a G8 call-sign followed by three letters. Applicants for a U.K. phone-only licence have to pass the Radio Amateurs' Examination.

European Fox Hunting Championships

THE fifth of a series of biennial Fox Hunting Championships arranged by the International Amateur Radio Union, Region I Division, will take place this year in Southern Bohemia, about 80 km from Prague. Organized by the Central Radio Club of Czechoslovakia an extensive programme has been drawn-up for competitors and visitors.

Participants will assemble at Tábor (on the main railway line from Prague to Česká Budejovice) on September 22nd, prior to the official opening on the following day when there will be practice runs for competitors. The Fox Hunts will take place on September 24th (3.5 Mc/s) and 25th (144 Mc/s) and on the 26th there will be visits to factories and places of historic interest. The entry fee for each member of a team will be U.S. \$30. This will cover accommodation, board and the full programme of events. The fee for visitors will be U.S. \$35 and will also cover the full period September 22nd-27th. Full details can be obtained from the secretary, C.R.C., P.O. Box 69, Prague 1.

Beacon Station on St. Helena.—Reception reports of signals transmitted from a beacon station on St. Helena will be welcomed by the R.S.G.B. Scientific Studies Committee, 28 Little Russell Street, London, W.C.1. The station transmits on 28.983 Mc/s in accordance with the following one-minute schedule: Test de ZD7WR, Test de ZD7WR, followed by an unmodulated carrier.

English DX News Bulletins are now being transmitted from Stockholm every Saturday at 14.00 G.M.T. on 7.025 Mc/s by the Swedish National Amateur Radio Society station SM5SSA. Transmissions are made at a speed of about 14 words per minute and the operators (SM5ACQ and SMDXU) stand-by from 13.00 G.M.T. every Saturday on 7.025 Mc/s for information to be included in that day's Bulletin. Items may be posted to P.O. Box 213, Vasteras, Sweden.

Amateur Radio at World Jamboree.—During the period of the World Jamboree of the Boy Scout movement (to be held this year in Farragut State Park, Idaho, U.S.A., from August 1st to 9th), radio amateurs of that State and of the American Radio Relay League will ensure that amateur radio is well presented to the boy scouts of the 80 countries expected to send contingents. The main amateur station—call sign K7WSJ ("World Scout Jamboree")—will be set up with three operating positions in tents on the camp grounds. Its primary frequencies will be c.w.: 3-525, 7-025, 14-025, 21-025 and 28-025 Mc/s; telephony: 3-950, 7-290, 14-290, 21-290 and 28-590 Mc/s. Another station, probably located outside the camp site, will be operated by Idaho amateurs using the call K7BS on frequencies 20 kc/s off those used by K7WSJ. The Jamboree-on-the-Air will take place during the weekend August 5th and 6th.

E-M-E Work Recognized.—The Technical Merit Award of the American Radio Relay League has been made to the U.S. West Coast amateur, William Conklin (W6DNG) and the Australian amateur Ray Naughton (VK3ATN) for outstanding earth-moon-earth work on v.h.f. W6DNG uses a pair of 4X250Bs running at nearly 800 watts output into a 32-element expanded collinear aerial producing a gain of 18.3 dB over a dipole. The array is rotatable both in azimuth and elevation. His receiver uses a transistor pre-amplifier in front of a converter, the output of which is fed through a noise clipping and blanking system into a much-modified Collins 75A-4.

Danish Jubilee.—The 40th anniversary of the formation of Eksperimentende Danske Radio Amatører—the Danish national amateur radio society—is to be celebrated in Copenhagen, at the Resturant Josty, Pile Alle 18, on Saturday, August 19th. Foreign radio amateurs in Denmark at that time who wish to attend the celebrations are invited to contact the secretary, F.D.R., Post Box 79, Copenhagen K.

Old Timers' Reunion.—Sir Francis McLean, Director of Engineering, B.B.C., was elected an honorary member of the Radio Amateur Old Timers' Association at the ninth reunion on May 5th, when a best-ever attendance of 85 was recorded. Making their first appearance were a number of pre-war artificial aerial licence holders. Membership of the Association is now 225 and is open to those who have held a full United Kingdom amateur transmitting licence for a period of 25 years including the war years as well as to pre-war artificial aerial licence holders who obtained a full licence in 1946 and have retained it ever since.

R.S.G.B. National Mobile Rally.—Gilwell Park, owned by the Boy Scout Association and situated on the edge of Epping Forest, Essex, is to be the venue of the R.S.G.B. National Amateur Radio Mobile Rally on Sunday, July 9th. Permission has been given by the Camp Chief (Mr. John Thurman) for cars and caravans to be parked at Gilwell from July 7th and although no reservations are required prior notification to Mr. J. M. Stuart (G3TU^{''}), 10 Stewards Close, Epping, Essex, will assist the arrangements. Talk-in stations will operate from 09.00 on 20, 40, 80 and 160 metres on the day of the Rally.

Artificial Ionosphere Cloud.—A study is under way to determine to what extent, if any, normal propagation conditions were disrupted by the artificial ionosphere cloud fired by rocket from Wallops Island, Virginia, U.S.A., during the evening of March 30th. Amateurs having knowledge of disruption of normal conditions that evening are requested to forward complete details to the American Radio Relay League, 225 Main Street, Newington, Connecticut, 06111.

JOHN CLARRICOATS, G6CL.

SORTING OUT THE COLOUR SIGNALS

How a colour television receiver takes the colour signal sidebands, centred on 4.43 Mc/s suppressed subcarrier, and demodulates them to isolate the two colour-difference amplitude modulations from which the drives to the three grids of the colour tube are derived

By T. D. TOWERS,* M.B.E.

IN previous articles we analysed the receiver sections in which the colour subcarrier is regenerated by a local oscillator kept in phase with the transmitter by means of the colour burst (June, 1967), and the demodulated chrominance signals are decoded into a form suitable for driving the three grids of the shadow-mask colour tube (May, 1967). Now we turn to the "chrominance" circuits where the colour signals themselves are isolated from the other signals in the transmission, amplified and then demodulated in two local-oscillator-controlled-demodulators to produce outputs suitable for the subsequent decoder circuits.

COLOUR SIGNALS FROM TRANSMITTER TO RECEIVER

To understand the chrominance section, it is well to take another look at the colour signals it handles. At the transmitter, the chrominance signals start as separate colour-difference signal voltages, $E_R - E_Y$ and $E_B - E_Y$, amplitude-modulated onto a subcarrier, $f_c = 4.43$ Mc/s, in 90° -apart phases. (This is the same as modulating onto two separate subcarriers $\sin 2\pi f_c t$ and $\cos 2\pi f_c t = \sin(2\pi f_c t + 90^\circ)$ as shown in Fig. 1(a).) The subcarrier is then suppressed and the resulting double-sideband signals are used to modulate the main transmitter carrier along with the luminance modulation, Y . This gives rise to colour modulation appearing as a 4.43 ± 1 Mc/s band upon the luminance modulation as shown shaded in the illustration for one raster line in Fig. 1(b). After the video detector in the receiver, these colour-difference modulations, separated from the other signals, remain as two sets of sidebands out to ± 1 Mc/s centred on 4.43 Mc/s as in Fig. 1(c). It is this last set of signals that the chrominance section of the receiver amplifies and demodulates.

COLOUR SIGNAL HANDLING IN CHROMINANCE SECTION

The overall separating, amplifying, and demodulating of the colour signals in the chrominance section is illustrated in block form in Fig. 2. After the video detector, the input signal to the chrominance section is a 0-6 Mc/s mixture of luminance (0-5.5 Mc/s), line sync pulse (d.c. with $0.3 \mu\text{s}$ risetime), colour-burst (4.43 Mc/s), f.m. sound ($6 \text{ Mc/s} \pm 0.15 \text{ Mc/s}$), and chrominance ($4.43 \text{ Mc/s} \pm 1 \text{ Mc/s}$).

In the first controlled chrominance amplifier stage, (A) in Fig. 2, the luminance signals between 0 and 3 Mc/s are removed, before the remaining 3-6 Mc/s is passed

on to the second stage, (B). Between (A) and (B), in passing, the 4.43 Mc/s colour bursts are fed off on a separate path to control the colour oscillator. The first stage A, moreover acts as a colour a.g.c. stage, gain-controlled by feedback from the colour oscillator section.

In the second stage, the "chrominance bandpass amplifier", (B) in Fig. 2, the chrominance signals are further isolated by removing the colour burst and sync pulse signals. This is done by a "gating" pulse during the line flyback which shuts the amplifier off when the sync and burst signals reach its input. The bandpass amplifier also usually includes a tuned 6 Mc/s trap to reject the sound signals, and sometimes a 1.57 Mc/s trap to reject the intercarrier beat between the sound (6 Mc/s) and colour (4.43 Mc/s).

Another feature of the chrominance bandpass amplifier is that it is controlled by a "colour killer" d.c. bias signal from the colour burst section. This holds the amplifier conducting during colour transmissions and cut off during black-and-white.

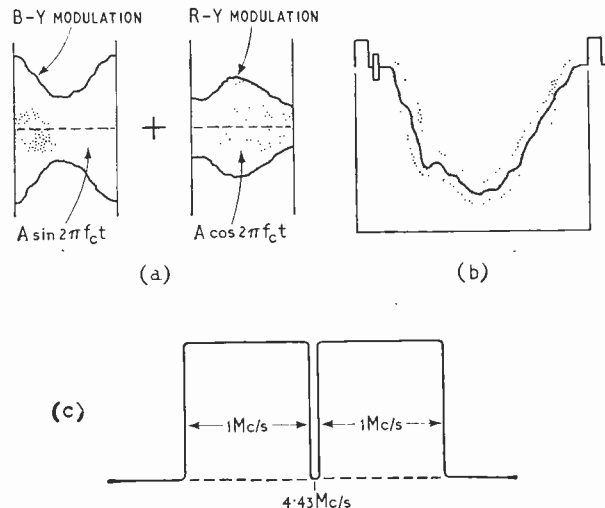

Fig. 1. How colour signals change from transmitter to receiver. (a) B-Y, R-Y amplitude modulations of 4.43 Mc/s subcarrier at 90° phase difference at transmitter. (b) Single line of transmitted signals showing mixed B-Y, R-Y modulated sidebands (shaded) "riding on" luminance signal (solid line). (c) Chrominance sidebands centred ± 1 Mc/s on suppressed colour-subcarrier after video detection and removal of sync pulses, colour bursts, luminance and sound signals.

*Newmarket Transistors Ltd.

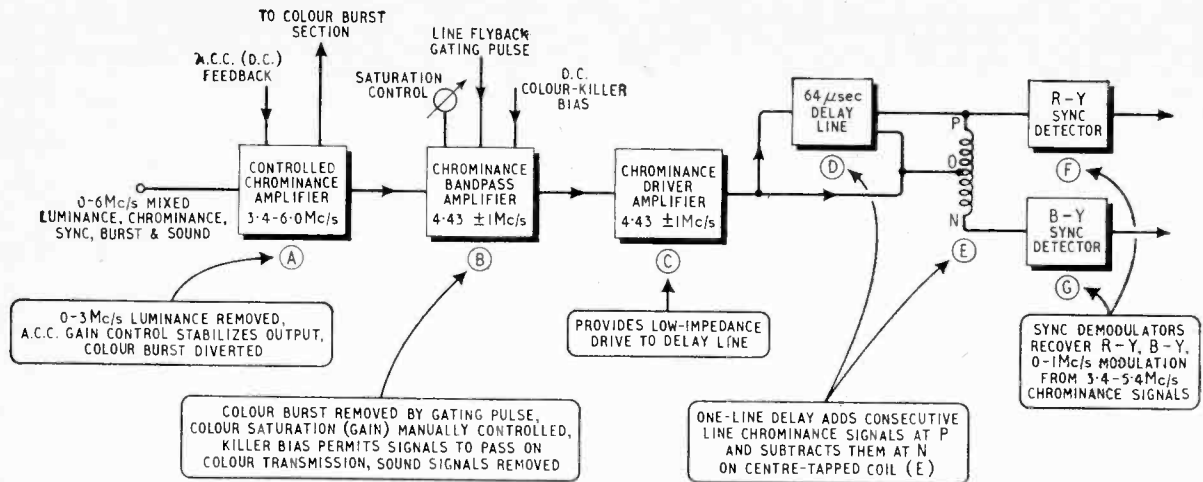

Fig. 2. Block diagram illustrating the processing of the colour-difference signals in the post-video-detector chrominance amplifier section of the receiver.

Finally, the receiver must have some form of manual control for the viewer to adjust the colour depth or saturation on the picture-tube screen, and this is usually located in the chrominance bandpass amplifier.

The third stage (C), in Fig. 2 is an impedance-changing stage included to provide a low-impedance drive in the correct phase to the next stage, (D).

The delay line (D), is peculiar to the PAL system, and will be discussed in detail later.

From the delay-line output transformer (E), the outputs to the colour demodulators (F) and (G) are signals from 3.4-5.4 Mc/s. These are combined in the synchronous detectors with the 4.43 Mc/s from the subcarrier-reinsertion oscillator, to give two separate, R-Y and B-Y, 0-1 Mc/s colour-difference signals. These final signals pass to decoder circuits which convert them to drive signals for the shadowmask, colour-tube grids.

UNWANTED SIGNALS BLOCKED OFF IN CHROMINANCE AMPLIFIER

Towards the end of this article we will take a look at a full commercial circuit for the chrominance section of a colour receiver, but, before we turn to that, we might well examine the sort of individual circuits to be expected to perform the various processes outlined above.

Luminance signals from 0-3 Mc/s are usually rejected by a simple high-pass RC filter like Fig. 3(a), although a more elaborate *m*-derived, high-pass filter as in Fig. 3(b), with infinite rejection at 1.57 Mc/s has been used to give rejection of the sound-carrier intercarrier beat as well.

Sound on 6 Mc/s can also be rejected by a simple tuned LC rejector circuit, Fig. 3(c), in the signal path.

There are many ways of applying line-blanking pulses to cut off the chrominance amplifier to prevent sync pulses and colour bursts passing through. The simple circuit of Fig. 3(d) illustrates one approach. It shows a transistor, Tr, biased normally into conduction by the network R_1, R_2 . During line flyback a negative pulse is applied via an isolating resistor, R_3 , to the base of Tr to cut the transistor off.

GAIN CONTROL IN CHROMINANCE AMPLIFIER

Circuits to control gain in the chrominance amplifier-section are needed for three purposes: for "a.c.c.", for

"colour killing" and for "saturation" level setting.

Colour a.g.c. or automatic colour control (a.c.c.) is usually applied to the first stage of the amplifier in some arrangement such as Fig. 4(a). The mixture of signals from the video detector is amplified in the n-p-n-transistor stage Tr. At its output the colour bursts are diverted on a separate path through a colour burst amplifier and phase detector and thence onward to control the phase of the colour local oscillator. However, the colour burst signal at the phase detector input is also fed off to the a.c.c. detector circuit D, C_1, R_1, C_2 which produces a negative d.c. output voltage proportional to the amplitude of the colour burst at that point. This negative voltage is fed back through R_1 to the base of Tr and provides a

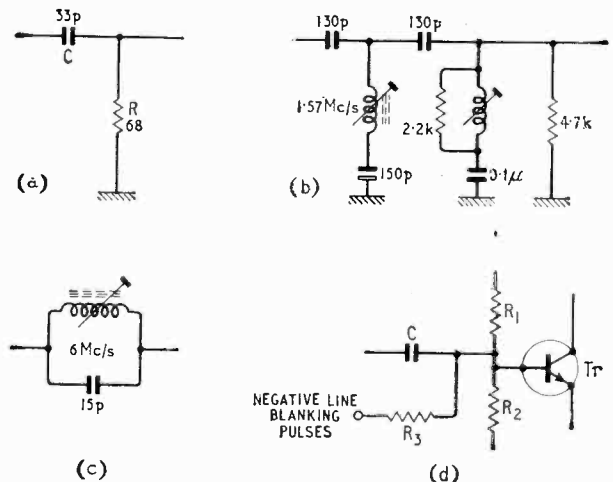

Fig. 3. Removing the unwanted signals entering the chrominance amplifier section of the receiver. (a) RC high-pass filter attenuates 0-3 Mc/s portion of luminance. (b) *m*-derived high-pass filter rejects 0-3.4 Mc/s luminance and 1.57 Mc/s sound-colour subcarrier beat. (c) LC parallel-tuned rejector eliminates sound signals around 6 Mc/s. (d) Line-blanking pulse used to cut off chrominance amplifier stage to suppress colour bursts.

bias that reduces the gain of that stage as the burst amplitude increases and vice versa. This form of a.g.c. ensures that the burst amplitude remains fairly constant at the output of Tr despite changes in the level of the incoming transmission signal. The preset potentiometer RV enables the a.c.c. level to be set up in manufacture or servicing.

Diode D in Fig. 4(a) gives a d.c. output only when colour bursts are being received, i.e. only when a colour programme is being transmitted. Now, we know that during black-and-white transmissions it is desirable to keep the chrominance amplifier turned off to avoid spurious colour signals passing through to the picture tube and tinting the display. You can do this by using this a.c.c. diode output as the d.c. bias source for a chrominance amplifier stage, which will be unbiased, i.e. cut-off, on black-and-white.

Using the output of the a.c.c. diode for colour killer purpose is the only method that can be employed with the American N.T.S.C. system. With swinging-burst PAL another approach is possible. Here, in the colour burst control loop for the local oscillator, there exists a 7.8 kc/s, half-line-frequency, ripple signal that is present only on colour transmissions. Some PAL designs rectify this ripple signal to provide an "on" bias for the chrominance amplifier. Fig. 4(b) illustrates such a swinging-burst "killer control" system. It shows a chrominance amplifier stage Tr receiving its base bias via a resistor R₂ from the ripple-detector circuit D, C₁, R₁, C₂.

Apart from a.c.c. and killer bias, the chrominance amplifier must, as noted earlier, have a manual "saturation" control. Just as the viewer can adjust the contrast in a black-and-white picture by means of a "volume control" in the video amplifier, so he should be able to adjust the depth of colour ("saturation") in a colour set to suit his eye. In some chrominance amplifier designs this saturation control takes the form of a simple potentiometer as shown in Fig. 4(c). Because it may be necessary to locate the saturation control some distance from the actual amplifier, difficulties can arise in arranging for adequate screening of the leads (which must carry 3.4-5.4 Mc/s). Because of this, it is more usual to find an arrangement such as Fig. 4(d), where the control is d.c. from a potentiometer, which can thus be located freely away from the chrominance amplifier. In the specific example of Fig. 4(d), the impedance of the diodes D₁ and D₂ in the signal path are varied by varying the forward bias applied via R₁, R₂ and R₄ from RV and R₃ across the d.c. supply rail. This provides a smooth saturation control without difficulties of lead screening or potentiometer location.

PAL DELAY LINE SECTION

The chrominance bandpass amplifier feeds into the PAL delay-line section, in which an ultrasonic, glass, delay line provides automatic electronic cancellation of phase (and hence colour tint) errors that may occur in transmission and reception. The most likely sources of such phase errors are mistuning of the receiver or the unequal response of the i.f. amplifier to the sidebands of the chrominance signal. In the PAL transmission, the R-Y phase is reversed on each line, so that in theory the phase errors on alternate lines tend to cancel themselves by optical averaging in the picture display. Such optical averaging is imperfect, however, and tends to degrade the picture. The complementary hue errors on successive lines of each field, can lead to the so-called "Hanover Blind" effect of a grid of horizontal, spurious-colour lines. At close distances this can be objectionable. Also it is often aggravated by the interlaced field scan arrangement which can introduce pairs of lines with alternating

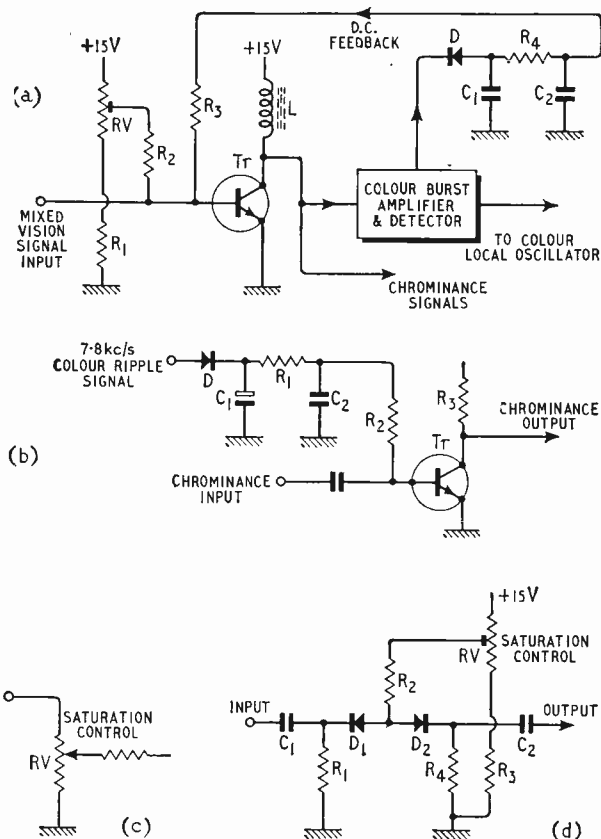

Fig. 4. Controlling the gain of chrominance amplifier for various purposes. (a) a.c.c.=automatic chrominance control=a.g.c. applied to amplifier stage so that output level (measured by colour burst amplitude) stays constant. (b) Killer bias control (PAL system). (c) Potentiometer control of saturation (gain). (d) D.C. voltage control of gain by biasing of diodes.

complementary hue errors. Rather than rely on imperfect optical averaging of the PAL-S (S=simple) receiver, the PAL-D (D=delay line) receiver avoids the Hanover Blind effect by cancelling the phase-errors electronically in a glass delay-line circuit so that the chrominance signals are phase-corrected before demodulation.

How this works in principle is shown in Fig. 5. During the $n+1$ th line the transistor feeds the chrominance ± 1 Mc/s sidebands centred on 4.43 Mc/s, denoted

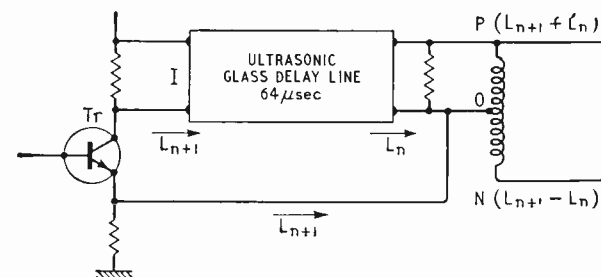

Fig. 5. Principle of combining successive lines of PAL transmission by means of a one-line delay element so that two outputs are obtained—one, at (P), corresponding to adding signals, and the other, at (N), to subtracting.

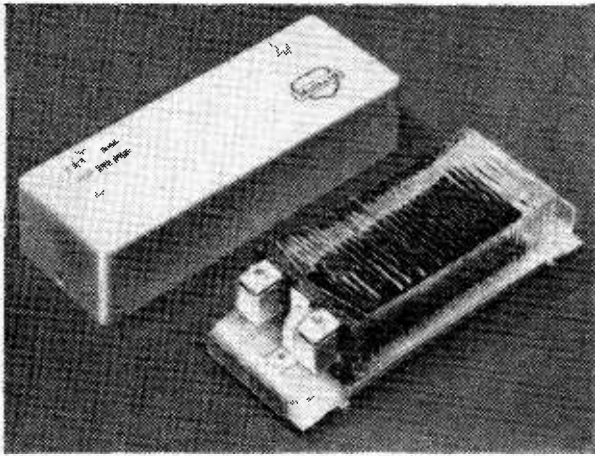

Fig. 6. Glass 64µs delay line for chrominance section of PAL-D colour receiver (Mullard type DL1).

line and from the emitter direct to the output, O. Meanwhile, the chrominance signals of the previous line, denoted L_n , after being fed into the delay line from the transistor collector have been delayed for one line period (approximately 64µs on 625-line transmission) in the delay line and are issuing from the output and coincide with the L_{n+1} signals arriving direct from the emitter. The delay-line thus stores one line of chrominance information. At the output, L_n and L_{n+1} are combined in a transformer, PON, to give two outputs, one the addition and the other the subtraction of consecutive line information. Because the $R-Y$ modulation is reversed in phase on each line, the "sum" output at P is largely $B-Y$ with the sidebands corresponding to $R-Y$ modulation on consecutive lines mostly balanced out. Similarly the "difference" output at N has the $B-Y$ sidebands much reduced leaving mostly $R-Y$ sidebands.

Meanwhile, the phase errors, which do not alter grossly from line to line, tend to balance themselves out in both $R-Y$ and $B-Y$ outputs.

PAL DELAY-LINE DETAILS

Fig. 6 gives an actual illustration of a commercial ultrasonic delay line, type DL1, developed by Mullard for PAL-D receivers. Made of glass with ceramic transducers, it has an insertion loss of only 10dB and a basic bandwidth of 2 Mc/s.

The colour subcarrier frequency of 4.43361875 Mc/s chosen for the system implies a total of 283.75 cycles per line-scanning period on the 625-line system. The delay-line must introduce a delay of an exact whole number of half-cycle periods, and the nearest to 283.75 are 283.5 or 284.0. The lower number, 283.5, is chosen because it requires no increase in the luminance amplifier delay which would be necessary if 284.0 were used. One colour subcarrier period is 225.549 ns, so the glass delay line is ground to produce a nominal delay of $283.5 \times 225.549\text{ns} = 63,943.0\text{ns}$. Experience so far has suggested that for satisfactory performance under normal operating conditions this must be held to a tolerance of about $\pm 3\text{ns}$. As $63943.0\text{ns} = 63.943\mu\text{s}$, engineers usually talk loosely of a "64µs" delay line.

The delay-line is designed to have an input and output impedance of the order of 150 ohms, and has inbuilt preset inductors across each end. These are to enable

the delay to be exactly adjusted and the output capacitance of the line to be tuned out so that it does not affect the add-subtract transformer across its output. The inductors are normally preset-adjusted in manufacture and only exceptionally should require adjustment by the user.

By the end of the chrominance amplifier and delay-line section the chrominance signals have been "tidied up" into a form suitable for feeding into the synchronous detectors which follow.

CHROMINANCE SYNCHRONOUS DETECTORS

These colour signal inputs to the synchronous detectors are double-sideband, suppressed-carrier, r.f. signals centred on 4.43 Mc/s, and containing $R-Y$, $B-Y$ information amplitude-modulated 90° apart in phase. The colour demodulation or detection process takes place in two separate demodulators, one for $R-Y$ and one for $B-Y$. Basically it consists of inserting a subcarrier from the receiver local oscillator exactly in phase with the transmitter-suppressed subcarrier, which means that the reinserted subcarrier for $B-Y$ will be phase-shifted exactly 90° from the $R-Y$ subcarrier.

There are many ways of carrying out this carrier reinsertion, but the process can be illustrated in the bridge diode type of synchronous demodulator finding increasing favour in current designs in the U.K. and illustrated diagrammatically in Fig. 7. This shows the 4.43 \pm 1 Mc/s output from the subcarrier fed single-ended into one apex of the four-diode detector bridge while the regenerated 4.43 Mc/s subcarrier is fed in balanced push-pull across the other arms of the bridge. The bridge then acts as an amplitude detector, and its output consists ideally of the 0-1 Mc/s colour-difference signal that was modulated at the transmitter onto that phase of the subcarrier which has been reinserted in the synchronous demodulator. A small residue of subcarrier signal also leaks through, however, due to the imperfect balance of the subcarrier reinsertion drive, but this is easily suppressed by the 4.43 Mc/s tuned LC output filter shown, leaving only the desired 0-1 Mc/s colour-difference modulation at the output.

COMPLETE CHROMINANCE SECTION

To gather together in perspective all the matters discussed above, Fig. 8 gives the circuit of the complete chrominance amplifier-demodulator section of a recent Mullard colour receiver design. This uses three v.h.f. silicon n-p-n transistor amplifier stages operating on a +15 V d.c. supply with a separate -20 V supply for the colour burst suppression circuit. Tr1 is the controlled chrominance stage, Tr2 the chrominance bandpass amplifier and Tr3 the delay line driver amplifier. D4-D7

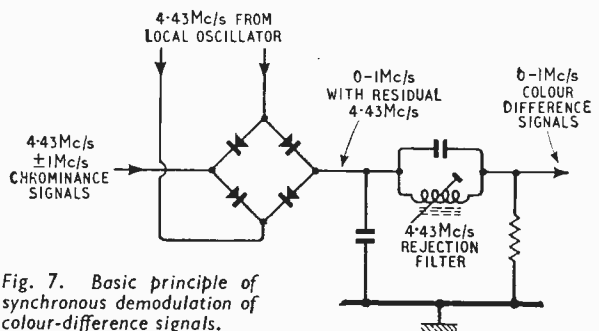

Fig. 7. Basic principle of synchronous demodulation of colour-difference signals.

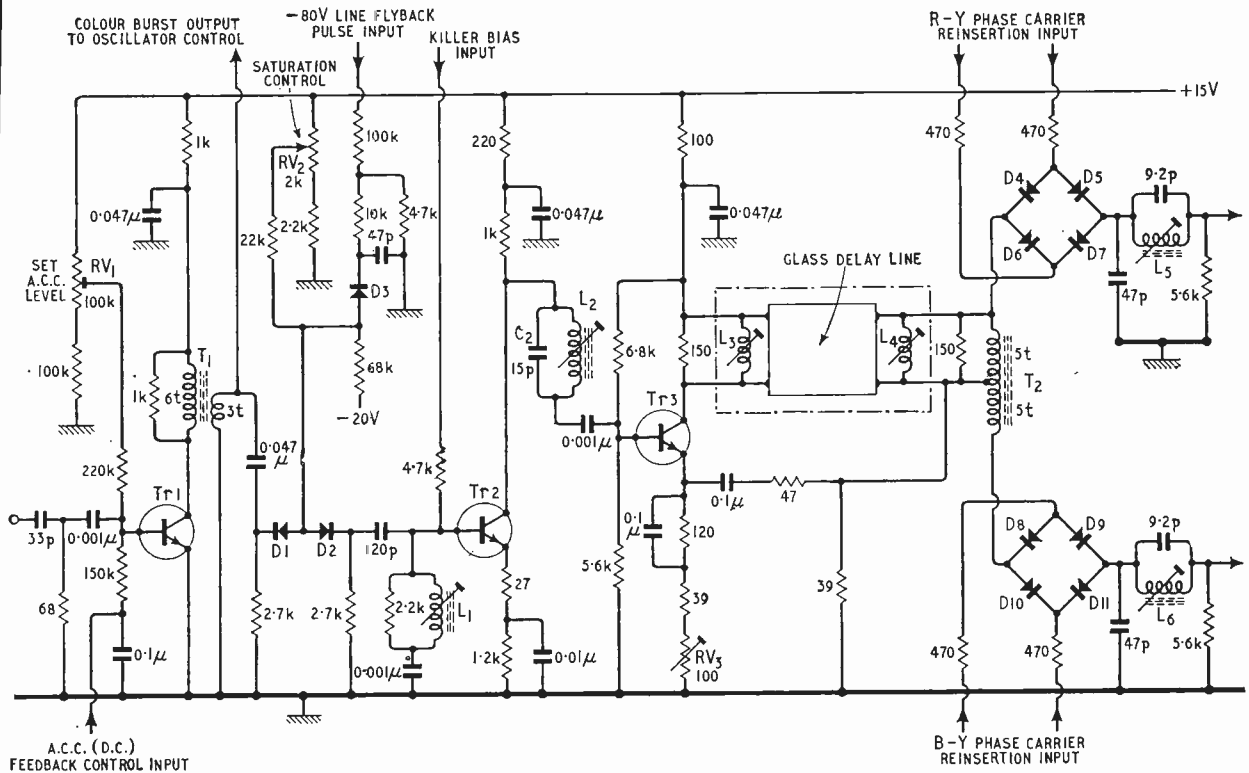

Fig. 8. Commercial design for complete chrominance amplifier and synchronous detectors.

L_{n+1} , from the collector to the input, I, of the delay- and D8-D11 are the two synchronous demodulators.

The 33 pF, 68-ohm high pass filter at the input of Tr1 removes from the 0-6 Mc/s much of the lower frequency luminance signals up to around 3.4 Mc/s. The remaining band of signals is amplified in Tr1 before the colour bursts are diverted at the secondary of its output transformer, T1, to the colour oscillator control loop. From this loop the separate d.c. feedback signal can be seen returning at the bottom left via 150 k Ω to the base of transistor Tr1 to provide a.c.c. by controlling its gain. The preset 100 k Ω potentiometer RV_1 sets up the a.c.c. level.

From the secondary of T1 the chrominance signals pass via a 0.047 μ F capacitor to amplifier stage Tr2. In this the potentiometer RV_2 applies variable forward bias to the diodes D1, D2 and varies their impedance. This variable impedance in the signal path constitutes a gain (colour saturation) control. Associated with this saturation control is the provision for preventing colour bursts passing through. An 80V negative flyback pulse from the line output transformer passes through diode D3 (which is normally biased cut-off) and cuts off the two diodes D1, D2. When cut-off, D1 and D2 present a very high impedance in the chrominance signal path, and the colour bursts are thus gated off in the amplifier.

In the stage Tr2 in Fig. 8, the inductance L_1 with its damping 2.2 k Ω resistor broadly tunes out the transistor base circuit capacitance at 4.43 Mc/s to maintain the required ± 1 Mc/s bandpass. D.C. bias to the base of Tr2 comes during colour transmission in the form of "killer bias" from the separate colour oscillator control loop. On black-and-white transmissions, the killer bias disappears, and, with no positive d.c. bias voltage to its

base, Tr2 is cut off, and no chrominance signals can pass through.

Tr2 is resistance-capacitance coupled to the delay-line driver, Tr3, via a tuned parallel-resonant 6 Mc/s retractor circuit L_2, C_2 which suppresses sound signals centred on the 6 Mc/s sound subcarrier.

The delay-line driver stage Tr3 is designed to drive the low-impedance 150-ohm, glass delay-line from its collector and to provide an undelayed signal direct from its emitter. The un-bypassed variable emitter resistor, RV_3 , enables the output from the delay-line to be set exactly equal to the direct signal from the emitter.

In the delay-line itself, the two preset inductances, L_3-L_4 are available to tune out the input and output capacitances of the line.

The delay line feeds into a centre-tapped, bifilar transformer, T2, wound on a ferrite core. This provides delayed chrominance signals of opposite polarities at its ends for adding to and subtracting from the undelayed signals which reach the centre tap via 0.1 μ F, 47 Ω from the emitter of Tr3. From the ends of the transformer separate R-Y and B-Y signals pass to the corresponding demodulators, D4-D7 and D8-D11.

The carrier reinsertion balanced inputs to the two demodulators come in correct phases (90° apart) from the separate local oscillator loop. The 0-1 Mc/s outputs of the demodulators then pass through 4.43 Mc/s subcarrier suppression parallel-tuned LC filters and arrive at the outputs in a form suitable for feeding subsequent decoder matrix circuits. (A full discussion of decoder circuits has already been given in a previous article in this series, "Colour Decoding Matrix Circuits," *Wireless World*, May, 1967).

Regulated Power Supply with Overload Protection

0 to 30-V transistor unit supplying 0.5A

By P. F. RIDLER, B.E., M.I.E.E.

THIS article describes a general purpose power supply intended to supply direct voltages to transistor circuits that is capable of delivering currents of up to half an ampere at any voltage in the range 0-30V. A feature of the instrument is a switchable current-limiting protective device. Although the supply is not intended to meet the highest standards of stability and regulation, it is quite adequate for the majority of laboratory projects and does cost so little that quite a number of the units can be constructed for the price of a single commercially manufactured supply.

The performance of the supply is modest, the more significant figures being:

Regulation: less than 0.5% no load to half full load

 " " 1% no load to full load

Ripple: less than 7 mV peak to peak at full load.

 " " 2 mV r.m.s. at full load.

Output impedance: less than 0.05Ω over audio frequency range.

DESIGN CONSIDERATIONS

The circuit is quite straightforward and is of the usual variable series impedance type, consisting of an unregulated supply with a transistor acting as a variable resistance in series with the load. A signal derived from the difference between a sample of the output voltage and a fixed reference voltage is applied to the input of a control amplifier and the output current of this amplifier varies the impedance of the series transistor. The elementary circuit diagram of such a supply is given in Fig 1, but the author contends that this method of interpreting the circuit is inconvenient, and does not allow the full use of experience which has been gained on other types of

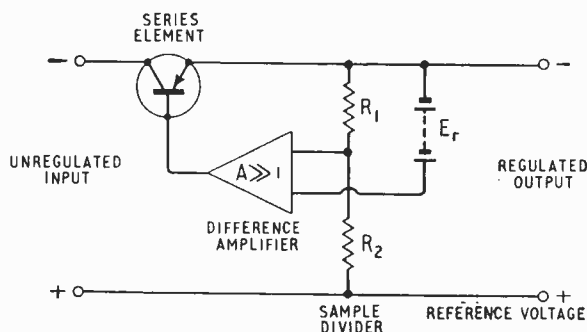

Fig. 1. Simplified circuit of power supply.

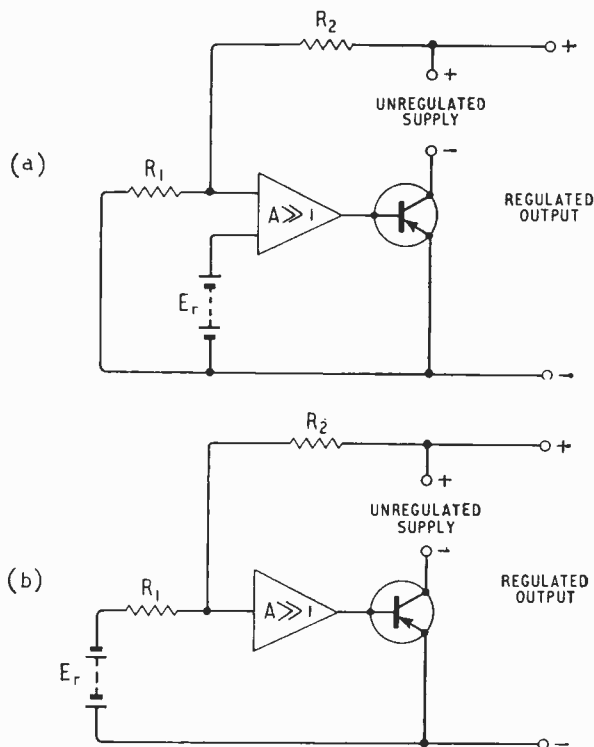

Fig. 2. Figure 1 redrawn illustrating that the difference amplifier is really a d.c. coupled operational amplifier.



Philip F. Ridler was educated in New Zealand and, after graduating in 1946, was with the Radio Section of the New Zealand Post Office. Later he joined Amalgamated Wireless (Australasia) in Sydney, leaving them to become a lecturer in applied physics at the University of New South Wales. In 1952 he joined the University of Khartoum and since 1960 has been head of the department of electrical engineering, Salisbury Polytechnic, Rhodesia.

feedback amplifiers; experience which can help considerably in the design procedure.

If the circuit diagram of Fig. 1 is redrawn as in Fig. 2a and then the reference voltage is moved as in Fig. 2b, it is immediately clear that this is the normal direct-coupled operational amplifier which is the fundamental unit of nearly all electronic analogue computers. The output of such an amplifier is equal to the (negative) reference voltage multiplied by the ratio of the shunt feedback resistor R_2 to the series input resistor R_1 , or

$$E_o = - \frac{E_r R_2}{R_1}$$

so that if R_2 is a variable, the output will be directly proportional to its resistance and can be varied from zero to any predetermined maximum. Any experience which may previously have been gained on operational amplifiers, or for that matter on any type of d.c. amplifier, may now be used to help in the design. The first thought that will occur, is that to achieve moderate degrees of stability it is normal practice to use a long-tailed pair in the first stage so that the thermal drifts in the two transistors of the pair will tend to cancel out. However, as with any other type of amplifier, it is usual to start the design from the output end. For the output voltage to cover the range 0 to 30 V, it is obvious that the voltage supplied by the unregulated supply must be rather higher than 30 V, and to allow for the drop in voltage when this supply is fully loaded, the no-load output voltage of this supply can be fixed at 40 V. Measurement or calculation will show that this supply falls to about 35 V when loaded to the

required 0.5 A using a normal design of transformer. The figures above show that the output transistor must have a collector voltage rating greater than 40 V, and in fact a transistor having a 60 V collector rating is specified. When the output of the supply is set to almost zero volts, then practically the whole of the unregulated supply voltage must appear across the output transistor, at the maximum load of 0.5 A this puts the dissipation in the output transistor at $0.5 \text{ A} \times 35 \text{ V} = 17.5 \text{ W}$. This dissipation is well within the capabilities of the TI3028 provided that a reasonable area of heat sink is used.

From the data sheet of the TI3028, the minimum current gain at 0.5 A is 50, implying that the driver transistor must be able to deliver $500/50 = 10 \text{ mA}$ to the base of the output stage. As the potential divider necessary for direct coupling will also draw some current, the driver stage should have a standing current of about 20 mA, of which it can pass on the necessary 10 mA when called upon to do so. When the driver is drawing the full 20 mA its collector will be at a potential of about 0.7 V, so that the dissipation is only $0.7 \text{ V} \times 20 \text{ mA} = 14 \text{ mW}$, with which any small germanium transistor can cope under normal ambient temperature conditions. When the output current is zero, then the full current will be flowing through the driver stage, Tr3 (Fig. 3), although the potential at the collector of Tr3 should not fall below about 0.7 V to avoid saturation. The base of the output stage Tr4 requires to be at only 0.3 V: this calls for the aforementioned potential divider between Tr3 collector and Tr4 base. From these preliminary

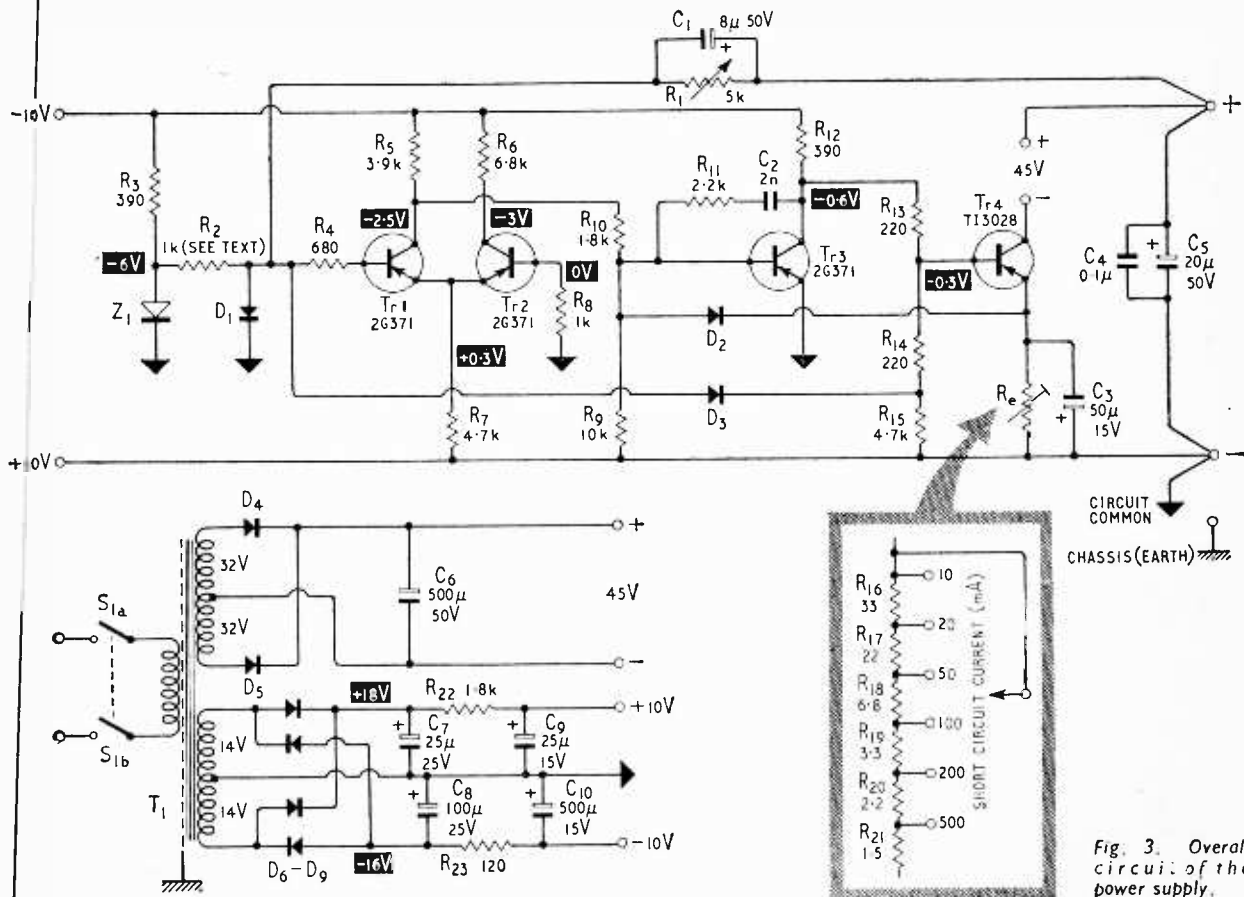
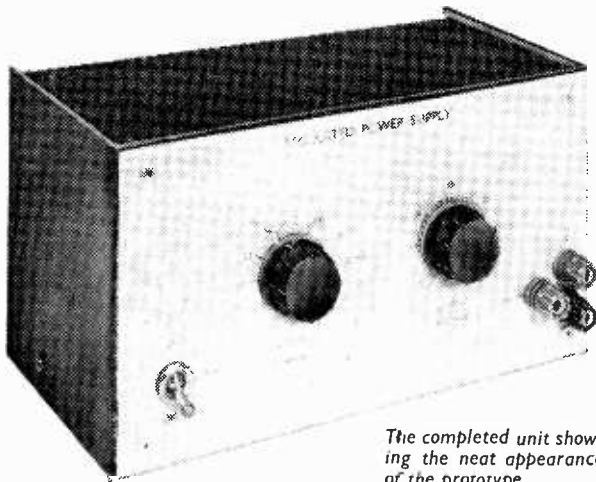
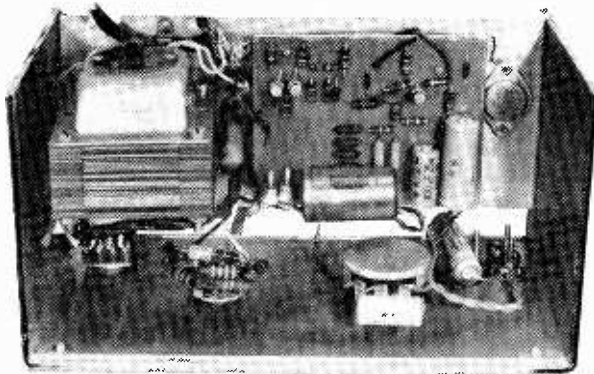

Fig. 3. Overall circuit of the power supply.



The completed unit showing the neat appearance of the prototype.



An internal view of the unit showing the layout of principal parts; note the mounting of the power transistor.

figures we can start to calculate some of the component values. The voltage across the driver load at zero output current is an auxiliary supply voltage of 10 V less the collector voltage of Tr3, i.e. $10 - 0.7 = 9.3$ V and the current through the load is 20 mA plus say 2 mA through the divider, so that the load resistance is $9.3 \text{ V} / 22 \text{ mA} = 420 \Omega$, or 390 Ω to the nearest 10% preferred value. We have allowed a current of 2 mA to flow through the divider, and as the drop across the top section is $0.7 - 0.3 = 0.4$ V, and the drop across the bottom section is nearly 10 V, the two resistors for the potential divider will be 220 Ω and 4.7 k Ω respectively. Fortunately this ratio will not reduce the gain of the amplifier seriously and there is no need to consider other voltage level shifters such as Zener diodes.

As was stated at the start of the design, previous experience suggests that the first stage should be a long-tailed pair. The current through each section of this pair should be the same in order to equalize any internal heating and, for the transistors specified, a standing current of 1 mA will be high enough to give reasonable current gain. The collector of each of the pair should run at about 3 V, which is high enough to avoid lowering of gain due to bottoming and low enough to allow a reasonably high value of load resistor to be used so as not to

rob the following stage of current. Again a potential divider will be necessary in order to allow direct coupling, but as the currents are much lower than in the later stages the bleed current through the divider need be only 1 mA. This gives the values of resistance for the two sections as 2.2 k Ω and 10 k Ω , the calculations being exactly the same as before. The load resistance is also calculated as before, the value for the active side being 3.9 k Ω , as there is a total current of 2 mA flowing in it, and that for the balancing side being 6.8 k Ω as here there is no potential divider current flowing as in the load resistor of Tr1. The series 680 Ω resistor in the base of Tr2 and the diode D₁ protect Tr2 from large current surges and excess reverse voltages respectively, which might otherwise cause failure under transient load conditions. The 1 k Ω resistor in the base circuit of Tr1 is an attempt to balance the base impedances of the two halves of the long-tailed pair. Local negative feedback through a resistor-capacitor combination from the collector of Tr3 to its base is employed to tailor the high frequency response of the amplifier in order to ensure that there is no overshoot when sudden changes in load take place.

The silicon diode D₂ is a current limiting gate: unless the voltage across the emitter resistor of Tr4 is greater than 0.6 V this diode is nonconducting, but if the output current becomes large enough to exceed this voltage across R_e the diode conducts, the gain of the amplifier is drastically reduced, the output voltage falls rapidly and the load current cannot be increased. By switching the value of the emitter resistor, the current limit may be set at any value up to the maximum rated current, although the current at which limiting commences is a little indefinite at the lower settings (Fig. 5). If a continuously variable control is desired, a wirewound inverse-taper variable resistor can be used, although this may be a little difficult to come by: the value should be 100 Ω . This form of protection is considered by the writer to be more satisfactory for general-purpose use than that which shuts down the supply when the load exceeds a certain value.

The purpose of the diode D₃ is not particularly obvious, but it prevents an output voltage surge which occurs

COMPONENTS LIST

Resistors

R1	5k	wire wound lin. potentiometer.
R2	1k*	R13 220
R3	390	R14 220
R4	680	R15 4.7k
R5	3.9k	R16 33*
R6	6.8k	R17 22*
R7	4.7k	R18 6.8*
R8	1k	R19 3.3*
R9	10k	R20 2.2*
R10	1.8k	R21 1.5*
R11	2.2k	R22 1.8k
R12	390	R23 120

Capacitors

C1	8 μ	50V	C6	500 μ 50V
C2	2n		C7	25 μ 25V
C3	50 μ	15V	C8	100 μ 25V
C4	0.1 μ		C9	25 μ 15V
C5	20 μ	50V	C10	500 μ 15V

Semiconductors

D1	OA70 (Mullard)
D2, D3	1S130 (Texas)
D4, D5	1S020 (Texas)
D6-D9,	1S130 (Texas)
Z1	6V 5% Zener (Texas)
	1S2062A or similar
Tr1-3	2G371 (Texas)
Tr4	T13028 (Texas)

Transformer

Primary: Standard mains.
Secondaries:—32-0-32V at 1 amp.
14-0-14V at 50 mA.

All resistors 1/4W 10% carbon except those marked with an asterisk which are 1/2W high stability.

when the supply is turned off under light load conditions. If this happens, the voltage of the unregulated supply decays slowly and control is lost over the output, as the control amplifier gain falls due to the more rapid decay of its power supply. This can cause a surge in output voltage of a magnitude greater than 10 V, which may be disastrous when applied to external circuitry. The diode D_3 is normally non-conducting, but when the internal supply collapses the anode of D_3 is made positive, by the current flowing from the unregulated supply through R_{13} , and this current can then flow to the base of Tr_4 , biasing it off and preventing the output surge. This diode is connected into the potential divider between Tr_3 and Tr_4 so that it is biased off under working conditions. Even with this precaution the time constants of the positive and negative internal supplies should be chosen so that they both decay

at roughly the same rate or a dangerous surge can occur at the output as the base of Tr_4 is pulled towards the more slowly decaying rail after the mains are switched off.

The auxiliary and main power supplies are quite standard. The auxiliary supply uses a double biphas rectifier giving both the positive and negative supplies for the amplifier. The diodes can be any general purpose diode with a peak inverse voltage of 50 V or greater and a direct current rating of 50 mA. The main supply requires 0.5 A diodes with a p.i.v. rating of at least 100 V. The transformer used was of the small utility power type rated at 250-0-250 V at 75 mA d.c. with a few filament windings. The secondary windings were removed and new secondaries wound: as the new voltages are quite low this is not a tedious job. The filter components for the auxiliary supply should be adhered to, as the values were chosen empirically to avoid the output surges referred to previously.

A capacitor across the feedback resistor progressively increases the loop gain with frequency, thus decreasing ripple and noise output. Another pair of capacitors across the output reduces the output impedance at frequencies where the gain of the amplifier falls off and fails to maintain the desired output impedance: the two capacitors provide a low impedance over the full frequency range.

CONSTRUCTION

Most components are mounted on a single-sided printed circuit board, the exceptions being the transformer and output transistor which are mounted directly on to the metal cabinet, the latter with the usual mica insulating washer. The whole circuit is isolated from case so that the supply may be used at either polarity with respect to earth, a separate earth terminal being provided. No metering was included, the output voltage dial being sufficiently accurate for most purposes, while a current meter would raise the cost to an unacceptable figure.

Details of the printed circuit and panel are given in

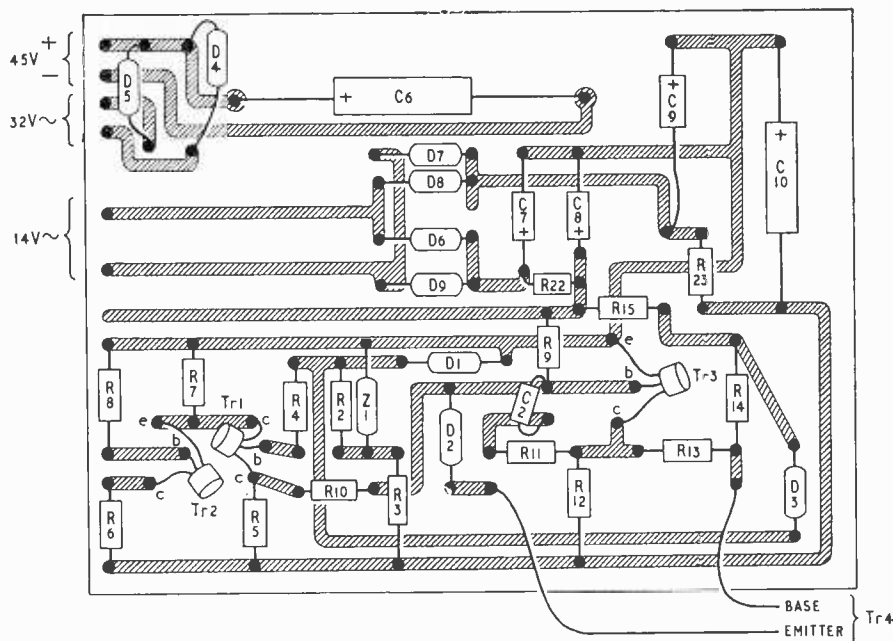

Fig. 4. The printed circuit board.

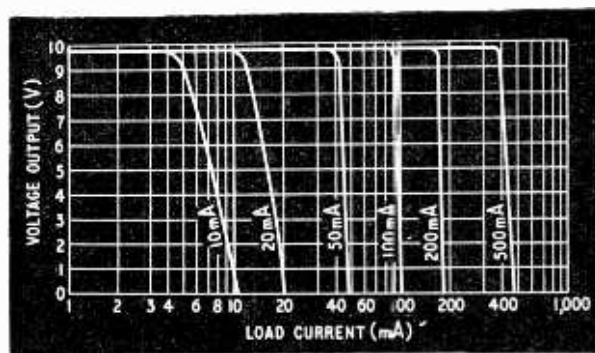

Fig. 5. Showing the performance of the overload protection circuits incorporated in the power supply.

Fig. 4 whilst the photographs show the general construction. No special precautions need to be taken in construction, except to ensure that separate leads are taken to the output terminals from the unregulated supply and from the feedback resistor as indicated on the circuit diagram. This ensures that the resistance of these leads does not degrade the performance. The 20 μ F and 0.1 μ F capacitors should be connected directly across the output terminals inside the cabinet.

When first switched on, the maximum output voltage should be measured and if this is high the value of R_2 should be varied to correct it. Provision is made on the circuit board for this, by making R_2 1.2 k Ω instead of the indicated 1 k Ω and allowing space for a second resistor to be connected in parallel with the 1.2 k Ω . This may be done quite safely with the power on until the correct value (usually between 3 k Ω and 10 k Ω) is found. This resistor can later be soldered in place.

LETTERS TO THE EDITOR

The Editor does not necessarily endorse the opinions expressed by his correspondents

Engineers – Professional and Technician

IN your Editorial in the June issue you draw attention to the clearly defined levels which are emerging in the engineering field and the establishment of professional bodies to cater for the technician.

I fully support the main contention of the Editorial, particularly the recommendation that recognition should be given to the status, work and qualifications of the technician.

However, I regard the last paragraph as niggardly in the extreme. It is implied that the Society does not apply its published Regulations with "unerring rectitude" and I consider this to be a slur on the Council and Membership Committee of the S.E.R.T.

Ever since the Society was established in June 1965 all applicants for membership have had to satisfy the entry requirements in their entirety and inspection of these requirements will show that appropriate examinations must have been passed for all three grades of membership. The list of examinations accepted is the result of an analysis of the many comparable qualifications and methods of training in this field.

A. J. KENWARD
(Secretary)

Society of Electronic and Radio Technicians,
London, W.C.2.

AS a Corporate Member of the Institution of Electrical and Electronics Technician Engineers I endorse the views expressed in the majority of your June Editorial, but strongly deprecate the implication in the last sentence thereof that the membership requirements for Corporate Membership of the Institution are sufficiently loose to make the designations M.I.T.E. or A.M.I.T.E. meaningless.

Admittedly when the Institution was originally formed Corporate Membership could be obtained by members of another association without paper qualifications. However, this practice has now ceased.

"Ring-of-three" D.C. Amplifier Design

MAY I congratulate Mr. Garside on his clear description in the June issue of a simple design method for determining the d.c. working points of the amplifier shown in Figs. 5 and 6.

This circuit was first described in British Patent No. 809,207 in October 1956. My article describing the bias principle involved was published in your sister journal *Electronic and Radio Engineer* (now *Industrial Electronics*) in May 1957. The patent is still in force.

As Mr. Garside realises, useful amplifiers must have their gain determined by feedback. This feature is further helped by the use of emitter-follower Tr2, which has the delightful property of reducing to a small series capacitance at infinite frequency thus increasing the forward gain without adding an extra "asymptote" to the loop-gain. This was pointed out in 1959 by Bowes of R.R.E.

However, the absence of emitter decoupling in Tr3 seems to limit the forward gain of the system to a value

There are now only two ways of obtaining Corporate Membership. The first of these is by having the necessary paper qualifications which are clearly set out by the Institution. The second is by transferring from Associateship to Corporate Membership by presenting and discussing an engineering report. In this case the regulations are quite clear and they entail a standard equivalent to that set by the educational requirements for Corporate Membership. Thus this method of entry is restricted to those people who have relatively senior positions and good technical knowledge. In this connection I would add that I have knowledge of quite a number of people in senior positions who, upon application, have been refused Corporate Membership and offered only Associateship due to the lack of paper qualifications.

I would suggest therefore that Corporate Membership of this Institution is now meaningful and that the Institution has established itself by limiting Corporate Membership only to those people who are suitably qualified.

A. G. F. HAWKINS

Winchester, Hants.

IN your leading article for June you said that you hoped that technician engineering societies would limit membership to those meeting examination requirements, thus making the designatory initials really meaningful.

Corporate membership of the I.E.E.T.E., denoted by the initials M.I.T.E. and A.M.I.T.E., is attained only by those able to satisfy the Institution's academic requirements and who have gained the requisite practical experience as well. Thus, the I.E.E.T.E. corporate member has qualified for admission in both respects.

E. A. BROMFIELD
(Secretary)

Institution of Electrical and
Electronics Technician Engineers,
London, W.C.1.

R_1/R_2 multiplied by R_1/R_3 , which, with the figures given is only just over ten times.

I would like to suggest that the emitter stick of Tr3 should be tapped at say 68 ohms from the emitter end and a large decoupling capacitor added at that point to ground. When this is done the second voltage amplifying transistor will have a gain of just over ten times and the overall gain will be 70. When this is reduced to 20 by the use of R_x and R_y , there will be almost 10 dB overall feedback.

The advantages of this simple biasing principle, which I prefer to call the "Bias-Loop Circuit" come into their own when the principle is applied twice to control the V_{cb} of both Tr1 and Tr3. When this is done the second d.c. feedback connection can also be the signal feedback element, or part of it.

J. SOMERSET MURRAY

London, N.W.2.

IN his article in the June issue Mr. G. Garside stated that if the value of β is increased from 30 at 10°C to 55 at 35°C when employing the potential divider and emitter resistance stabilization circuit, then the voltage across R_e (Fig. 3) and the current through R_e would be unchanged.

Surely to be more precise the increase of β due to a rise in temperature will cause an increase in I_e and the emitter voltage will tend to approach that of the base, the base-emitter voltage therefore tends towards zero. Thus negative feedback due to R_e will tend to reduce the collector and emitter currents. This tends to offset the increase in current gain. However, the collector current will finally equalize itself to a value which is slightly higher than it was at a temperature of 10°C. I have ignored the effect of the increase in collector currents.

D. A. OAKENFULL

London, S.E.22.

The author replies:

I AM indebted to Mr. Somerset Murray for bringing to my attention, and to that of the readers of *Wireless World*, the facts concerning patent protection of the circuit given in Figs. 5 and 6 in my article. I had previously regarded the circuit as being one of a class, the members of which having "just grown." In connection with his remarks concerning the decoupling of Tr3 emitter, however, some confusion seems to have arisen, and as a result of this I am prompted to mention another aspect of the circuit which was not specifically discussed in the article, viz: stability.

In fact, in both Fig. 5 and Fig. 6 Tr3 is shown to be decoupled for signal voltages by capacitor C , mention of which is made in the text. In general it is extremely desirable that no signal voltage variations be present at Tr3 emitter for, although the consequent a.c. feedback via R_{FB} is nominally negative, it can happen that the circuit becomes unstable. In the article a conservative estimate of the β of Tr1 was made, and in practice the value could be up to an order of magnitude greater: if this is found to be the case, R_{FB} would have to be made 180 k Ω , and small stray capacitances then become quite important, as, for example, the capacitive reactance associated with 10 pF is 160 k at a frequency of 100 kc/s. The input resistance of Tr1 also increases, approaching 150 k Ω , and Miller capacitance effects become significant if account has to be taken of the circuit performance at these higher frequencies.

Since the article confined itself to low-frequency applications, I thought it simpler firmly to decouple Tr3 emitter rendering the considerations above largely irrelevant. The position of the decoupling capacitor is perhaps unusual, but is in my opinion better practise than the more normal configuration in which C appears across the emitter resistor. To experimenters wishing to implement Mr. Somerset Murray's modification—including some current feedback in Tr3—I would therefore recommend that great care should be taken if instability is to be avoided.

I should like to turn now to the letter from Mr. Oakenfull. I think that he and I have, in reality, little difference of opinion, and I am in agreement with his elaboration of the stabilizing circuit action of Fig. 3. In the article I chose to adopt a viewpoint which, in effect, had for its basis the constancy of the voltage across a forward-biased semiconductor junction, and asked readers to regard this "fact" as axiomatic. Having adopted this approach the stabilizing action of the circuit of Fig. 3 was most simply appreciated, I feel, by consideration of the argument given in the article. Mr.

Oakenfull's analysis is more fundamental, in that the validity of my axiom is investigated along with the circuit action. If a typical temperature coefficient of voltage is adopted for the base emitter junction, the change in collector current is, to a first approximation, about 10% (normally negligible in engineering terms), compared with 80% as calculated for the circuit of Fig. 2.

Incidentally, an error appeared in the published text of my article. In column two on p. 269 the statement " R_H is in parallel with Z_{IN} and may, therefore, be neglected..." is incorrect. It is the effect of Z_{IN} which is negligible under the conditions specified and this is implicit in the formula which follows.

G. GARSIDE

Current/Voltage Measurements

THE article "D.C. Nanoammeter and Micro-voltmeter" by D. Bollen in the May issue reminded me of a related problem and solution which I use.

Students are commonly required to take measurements and from them to plot the current/voltage characteristics of various devices such as carbon and tungsten filament lamps, thermistors and thermionic and semiconductor diodes. In many cases the amount of power which is required to operate simple conventional meters is of the same order as that which is to be fed to the device under test, and while allowances can be made for this state of affairs, these do detract from the simple nature of the experiments.

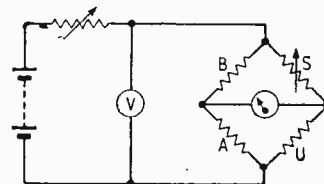

The circuit is set up as is shown in the diagram, where A and B are the 'arms' of the bridge (usually adjustable in decade steps), S is preferably adjustable in a continuous manner and U represents the device under test (correctly connected with reference to the battery if the device is polarized).

When the bridge is balanced, then, as usual

$$U = \frac{AS}{B}$$

If now A is made equal to B , then not only is $U = S$ but also the voltage cross U is half of the value indicated on the voltmeter. A resistance/voltage characteristic is

Continued on next page

Wireless World DIGITAL COMPUTER

The first of a series of articles on the design and construction of a computer will appear in the August issue. Costing in the region of £60, it is designed to teach the elements of computer programming and binary arithmetic and will therefore be of particular interest to schools.

now taken, and this may easily be converted to a current/voltage characteristic or any other derivative that might be required.

For very high and very low values of U , the measurements are not quite so convenient because it may not be desirable to use $A = B$, so that the voltage

$$\frac{AV}{A+B}$$

across U will involve a little more slide-rule work.

R. C. WHITEHEAD

Dept. of Electronics & Telecommunications,
Northern Polytechnic, London, N.7.

Constant-current Circuits

I QUITE agree with Mr. Williams's remarks in his letter in the June issue, as far as they are applicable. But it seems to me that his first point of criticism does not really arise, because R_1 is made variable deliberately, enabling Zener current I_z to be set to the desired value, irrespective of β_2 . This makes further resistors (R_2 and R_3 in Fig. 1 of Mr. Williams's letter in September 1966) unnecessary, thus avoiding the additional p.d. which would otherwise have to be deducted from the useful battery voltage range.

$I_z = I_{c2} - I_{b3}$ (neglecting R_2 in my Fig. 3), where I_{c2} is approx. constant and given by β_2 and setting of R_1 , and $I_{b3} = I_L/(\beta_3 + 1)$, where I_L = load current. As stated in my first letter, the choice of the no-load current I_0 (substantially I_{c2}) is a matter of compromise, a higher value giving better stabilization, particularly with change

of I_L . If I_L does not vary much, a smaller I_0 could be chosen. As a rough guide,

$$I_{c2} \leq 2I_{Lmax}/\beta_{3min}$$

should give a reasonable starting point.

The values shown for R_1 are only a typical example and can be varied as required. (To cover the full β range of BC 108s, at $I_0 \approx 1$ mA, 680 k Ω would be a better choice for the fixed part of R_1 .)

I should like to add that the circuit was not intended as a high-performance stabilizer operating over a wide load current and temperature range. Nevertheless, a variation of output of less than 2% over an extended battery life, and less than 1% drift over a normal range of temperatures (typical figures), seem more than adequate for many applications.

Regarding Mr. Williams's last point, my remarks about R were perhaps rather unfortunately worded (for reasons of brevity), the implied idea being that R should be reasonably large as well as having sufficient current flowing through it, which immediately contradicts the requirement for a low p.d., and points towards a constant current circuit. My curves were taken with $I_L = 20$ mA, my omission.

London, N.W.2.

G. N. E. PASCH

Painful!

I WAS interested to learn of the triumph of hertz over cycles/second, especially when I realized that a cycle became a hertz second. Accordingly, I stated in a recent lecture to the I.E.E., that "... each output transistor conducts on alternate half-hertz seconds."

I am now wondering which hertz most.

J. DINSDALE

Farnborough, Hants.

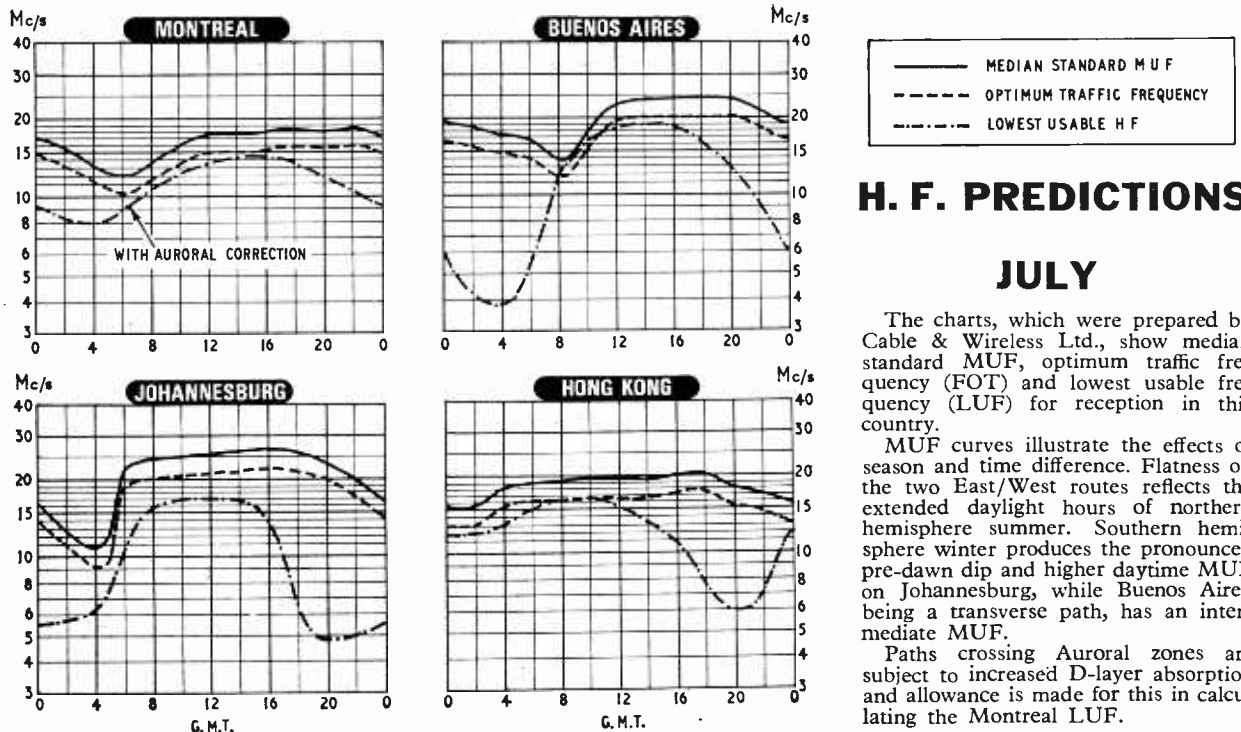

H. F. PREDICTIONS

JULY

The charts, which were prepared by Cable & Wireless Ltd., show median standard MUF, optimum traffic frequency (OTF) and lowest usable frequency (LUF) for reception in this country.

MUF curves illustrate the effects of season and time difference. Flatness on the two East/West routes reflects the extended daylight hours of northern hemisphere summer. Southern hemisphere winter produces the pronounced pre-dawn dip and higher daytime MUF on Johannesburg, while Buenos Aires, being a transverse path, has an intermediate MUF.

Paths crossing Auroral zones are subject to increased D-layer absorption and allowance is made for this in calculating the Montreal LUF.

Thorn Special Products Ltd—among the leading manufacturers and suppliers of high quality components for the professional, electrical, electronic and aircraft industries—offer the widest range of products plus a complete service in instrument panel lighting. Technical literature is freely available.



Thorn Special Products Ltd

GREAT CAMBRIDGE ROAD, ENFIELD, MIDDX. ENFIELD 5353
a member of the Thorn Electrical Industries Ltd group of companies

High Quality Components for the Professional User

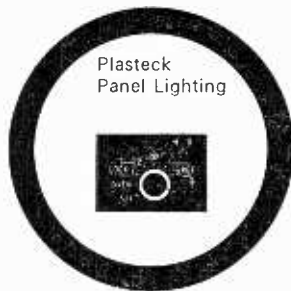

Plasteck
Panel Lighting

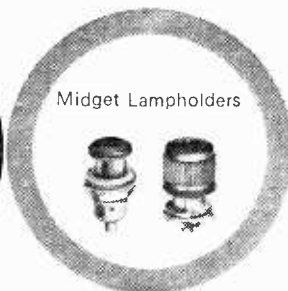

Midget Lampholders



Press Switches



Digital Indicators

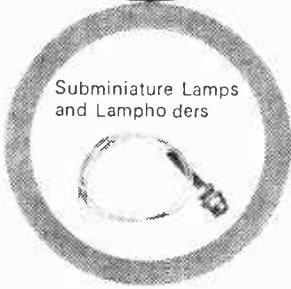

Subminiature Lamps
and Lampholders

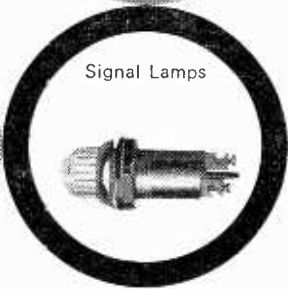

Signal Lamps

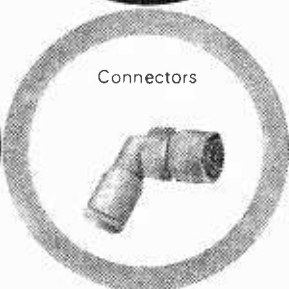

Connectors

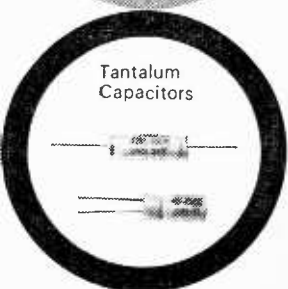

Tantalum
Capacitors

FROM THORN

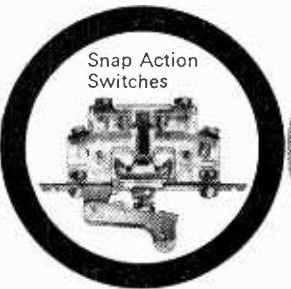

Snap Action
Switches

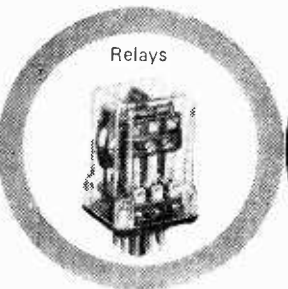

Relays

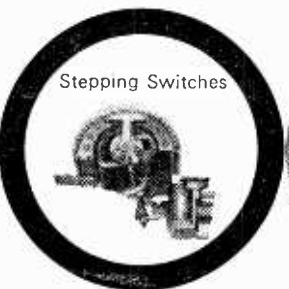

Stepping Switches

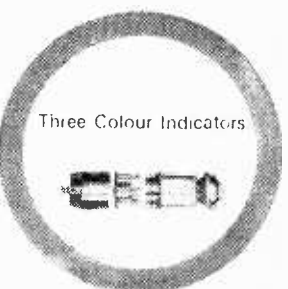

Three Colour Indicators

WW-089 FOR FURTHER DETAILS

Best performance under the sun!

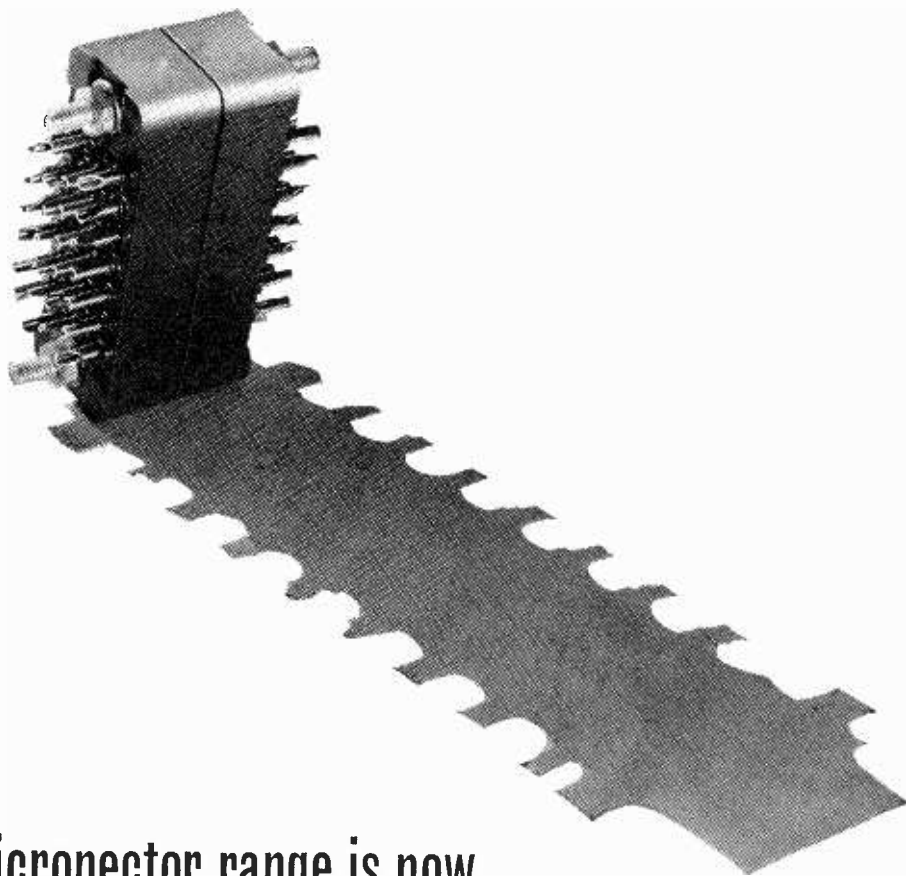

McMurdo Micronector range is now improved with D.A.P.* for tropical efficiency

***DIALLYL PHTHALATE** – the robust plastic material that McMurdo have chosen for the improved **Micronectors**. This is the highest quality material of its type available for tip-top tropical performance because it has really exceptional electrical and mechanical properties and supercedes the moulding formerly made in melamine. For the finest, fool-proof connections under the sun – you've got to take your hat off to McMurdo! Write for full details of the **Micronector** range now!

McMURDO
ELECTRONIC COMPONENTS

Write to: Technical Sales Department,
THE McMURDO INSTRUMENT COMPANY LTD.,
RODNEY ROAD · FRATTON · PORTSMOUTH
TEL: PORTSMOUTH 35361 · TELEX: 86112

LUGTON & CO. LTD., 209/210 Tottenham Court Road, London, W.1. SASCO, P.O. Box No. 20, Gatwick Road, Crawley, Sussex. Telephone: Chipping Sodbury 2641. Cumbernauld 25601. Hitchin 2242.

NORWAY: J. M. Feiring A/S, Lilletorvet 1, OSLO. PERU: Estemag Peruana S.A., P.O. Box 2838, LIMA. PHILIPPINES: C. & C. Commercial, P.O. Box 2419, MANILA.

WW—090 FOR FURTHER DETAILS

RC Notch Filter

Active circuit for suppressing selected audio frequencies

By G. W. SHORT*

THE notch filter described here was developed for eliminating the fundamental frequency in distortion measurements, but it is applicable also to whistle or hum suppression. The essential part (Fig. 1) is a balanced Wien bridge with a transistor across the floating terminals. There is no output at the balance frequency $f_0 = 1/[2\pi \sqrt{(R_1 R_2 C_1 C_2)}]$, and the balance frequency is not affected by the input impedance of the transistor.

This simple arrangement is lacking in selectivity. The response is still 6dB down at twice the null frequency. This is a nuisance in harmonic distortion measurement, and the circuit takes rather too large a bite out of the audio spectrum in other applications. Fortunately the selectivity can be made much sharper by applying positive feedback. There is no feedback at the null frequency, so the attenuation is still large, but the feedback is operative at either side of the null, and raises the gain at off-tune frequencies. The loss at the second harmonic can easily be reduced to 1dB. The risk of instability is small.

A complete practical circuit is shown in Fig. 2. The component values of the Wien network here fix the null at about 960 c/s. For whistle-filter service, R_1 and R_2 may be ganged potentiometers. The setting of the balance control R_4 is critical. Note that the bridge must now be slightly unbalanced to obtain a null at the output. This is because some of the input signal can pass directly to the output via positive feedback resistance R_{11} . Just enough of the null-frequency signal must be applied to Tr 1 to cancel this.

It is convenient to adjust R_{11} so that, at frequencies well off tune, there is no overall insertion loss.

In distortion measurements some means of setting up the circuit so that the output is standardized at the fundamental frequency is required. If a large capacitance is connected across the lower branch of the Wien network C_2 , R_1 the bridge is unbalanced and the frequency response is levelled. One way of achieving the necessary circuit change is to take the positive side of C_1 to a changeover switch so that in the alternative position C_1 is connected between the base of Tr1 and earth. However, if the test oscillator is variable it is easier to leave the bridge alone and retune the oscillator to some frequency well removed from the notch but still within the mid-band range of the amplifier or circuit under test. R_5 should be adjusted to keep the input to the bridge to 1 V maximum, to avoid overloading. The oscillator is then tuned to the null frequency and the output measured again. The percentage ratio of the measurements is the distortion factor:

$$d.f. = \frac{\text{Harmonics + noise}}{\text{Fundamental + harmonics + noise}} \times 100 \text{ (per cent)}$$

The measurements should strictly be made with a true r.m.s. meter, but an ordinary averaging meter gives a

Fig. 1 Simple Wien bridge and transistor arrangement.

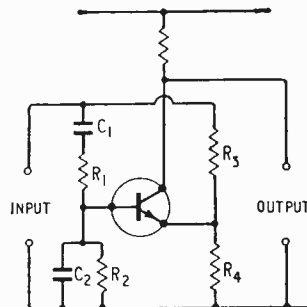
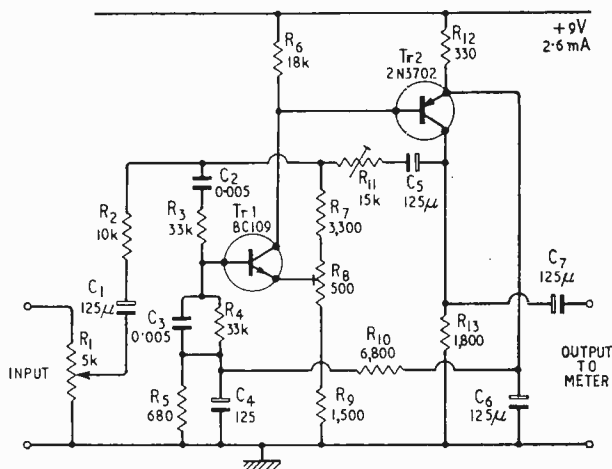

Fig. 2 Practical filter circuit using positive feedback to obtain good selectivity.



reasonable indication. When testing amplifiers, distortion factors below 10% are of most interest and some means of increasing the sensitivity of the measurement of the harmonics and noise is needed. The usual way of doing this is to increase the sensitivity of the meter but in the present case there is another possibility. The filter will handle at least 10 V at the null frequency, so if ample signal is available R_1 may be calibrated and used as a $\times 10$ multiplier, giving f.s.d. for a distortion factor of 10 per cent. However, for measuring really low distortion a meter of variable sensitivity is necessary.

An alternative tuning arrangement consists of replacing the series arm of the Wien RC network with a resistance and the parallel arm with a parallel-tuned LC circuit. Balance can then be obtained at the resonant frequency. In this form the notch network has possible applications in radio receivers; e.g. as an interfering-frequency rejector tunable across the i.f. passband.

* Amatronic Ltd.

Design of Negative-feedback Equalizers

Method for audio applications, using RC network in feedback path

By G. A. STEVENS

IN all forms of recorded music an equalizer is required in the replay chain. That is to say, if the form of modulation (magnetization in tape recorders, track deviation in records, optical density on film sound tracks) were to be converted proportionately to sound intensities, then the ratio of the original to the reproduced sound would vary over the frequency range. Obviously the ratio of the two sound intensities (usually normalised to zero at some mid frequency) gives the total frequency correction needed to reproduce the original sound as nearly as possible.

The failure of a replay process to give a flat response may be due to any of the following factors:—

1. Pre-emphasis introduced onto the recorded medium by the recording process to improve signal/noise ratios.
2. Characteristics inherent in the replay equipment (such as the 6 dB/octave response of a magnetic replay head).
3. Frequency dependent losses in the system (such as gap effect and magnetic losses in tape heads).
4. Frequency distortion in the loudspeakers.
5. Room acoustics.

There is also a need to modify the frequency response to suit individual tastes. Usually as a person's age increases his ability to hear the higher frequencies decreases and a reduced high frequency response sounds less harsh to his ears, as it does initially to people unused to high quality reproduction. Older 78 r.p.m. records often have an objectionable surface hiss which may be reduced by removing the upper frequencies.

Of the above factors the first three are easily measurable by means of a standard frequency test recording, and an a.c. voltmeter in parallel with the loudspeaker.

The other factors listed vary with the type of loudspeaker used, its enclosure, the age of the listener and the age of recording, and, since even the number of people in a room affects its acoustics, it is obvious that only some form of continuously variable control can accommodate all the variables involved.

Since, for the first group, the frequency response remains fixed for a given replay system there is no need to vary the response continuously, and so fixed circuits may be devised and switched into circuit for a particular system when needed.

The tone control is used to compensate for the last two items in the factors listed, and to accommodate listeners' tastes, while the equalizer caters only for the first three characteristics listed.

In any passive, non-resonant, equalizer there is never any overall gain, and, for example, a bass boost circuit does its "boosting" by attenuating all frequencies other than the bass. This means that the nominal total overall boost of an equalizer of this type, referred to a nominal centre frequency (usually 1 kc/s), is equal to the insertion loss at this frequency.

Drawbacks of passive equalizers

Since the output of high quality transducers is often of the order of a few millivolts, feeding such an output directly into a passive equalizer would reduce the equalized output to a very low level indeed and bring hum and noise up to an objectionably high level. If instead the signal is fed to an amplifying stage before the equalizer, more complications follow. First, the gain of this stage must not be too high, otherwise the frequencies having the greatest amplitude will be high enough to cause distortion at the output of the first stage. Secondly, pre-amplifiers are usually designed to accept several inputs selected by a switch, and then equalize and amplify them and feed them to an output at a standard level, regardless of input level. This would mean that, in the amplifying and equalizing system, all the signals would first have to be attenuated to the level of the smallest input before they were applied to the input of the first stage, and then another switch would have to select the correct equalizer network. There is also the complication that the input impedance of a passive equalizer network can be quite low, and in any case varies over the frequency range, and can therefore upset the working of the preceding stage.

These drawbacks of "wasted gain" always degrade the signal/noise ratio of the output. Resonant equalizers in some cases could provide an answer, but for the usual 6 dB/octave slope elements that are normally required they are useless. In any case the inductors needed are likely to be expensive, are prone to hum pick-up, and can take up considerable space. If, however, the required equalizer networks are incorporated in a negative-feedback loop the "wasted gain" of the original circuits can be utilized to provide the benefits associated with feedback amplifiers. These are:—

1. Low output impedance, allowing long capacitive leads from the output to the next unit.
2. Fixed high input impedance.
3. Improved signal/noise ratio.

Also, switching is simplified as only the input circuits of the valve have to be switched.

The operation of this type of circuit is illustrated by Fig. 1.

G. A. Stevens has for the past five years been a maintenance engineer with Rediffusion Television Ltd. From 1952 until being called up for National Service in the R.A.F. in 1959 he was in the Research Laboratory of E.M.I. which he joined on leaving school at the age of 19.

An input signal, V_i , is connected to the input of an amplifier (of voltage gain $-G$), via a resistor R . Part of the output, V_o , is fed back via resistor nR . This is actually made a potentiometer whose wiper is connected to an a.c. voltmeter, for reasons that will be shown later. The voltage actually applied to the input of the amplifier is V_g .

Considering the currents flowing in the circuit (assuming the amplifier has a high input impedance relative to the input circuits), we have:—

$$I = \frac{V_o - V_g}{nR}$$

but since $V_g = -\frac{V_o}{G}$

we can write

$$I = \frac{V_o - \left(-\frac{V_o}{G}\right)}{nR} = \frac{V_o(G+1)}{nRG}$$

also since

$$V_i + IR = V_g = -\frac{V_o}{G}$$

$$V_i = -\frac{V_o}{G} - IR = -\frac{V_o}{G} - \frac{V_o(G+1)}{nRG} \cdot R$$

$$= -\frac{V_o(n+G+1)}{nG}$$

$$\therefore \frac{V_o}{V_i} = G' = \frac{-nG}{n+G+1} \dots \dots \dots (1)$$

so that the feedback has reduced the original gain by a factor of

$$\frac{n}{n+G+1} = \frac{1}{k} \text{ (say)}$$

Imagine now that the original gain, G , of the amplifier was -20 (the negative sign merely denoting the phase change in single-stage amplification). If the output were 20 volts r.m.s., say, then this would be the value shown on the voltmeter if the slider of nR were at the output end. This is represented as point B in Fig. 2. Now, if the wiper were rotated to the input of the amplifier, it would read 1 volt as represented by point A in Fig. 2. As can be seen, at one point of its rotation the potentiometer gives no output. This also holds for the 80, 60 and 40 volt outputs shown, and obviously this will be the case regardless of output level, so this point "0" on the diagram is, as far as a.c. signals are concerned, at earth potential, and in fact is called the "virtual earth." If Fig. 2 had the same scales for positive and negative voltage axes it would be seen that the ratio $B0:A0$ is $-20:1$, i.e. the gain of the amplifier $-G$. From this it can be seen that the length of the line $A0B$, representing the value of the resistor nR , is given by the factor $(G+1)$.

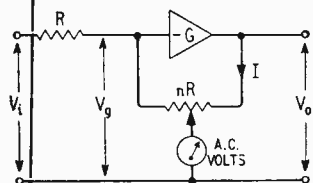

Fig. 1. Basic feedback circuit.

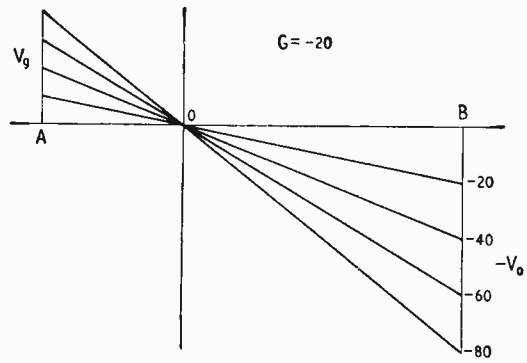

Fig. 2. Voltage gradient across feedback resistor. When $-V_o = -20V$ then $V_g = 1V$.

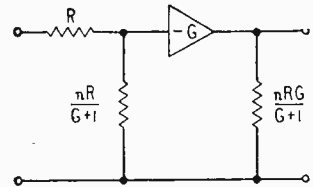

Fig. 3. Equivalent circuit of basic feedback network.

Then $A0$ is $\frac{nR}{G+1}$ and $B0$ is $\frac{nR \cdot G}{G+1}$. This means that the circuit of Fig. 1 could be re-drawn as shown in Fig. 3, i.e. an amplifier of gain $-G$, preceded by an attenuator, with series arm R and shunt arm $\frac{nR}{G+1}$, and an output shunted by a resistor of value $\frac{nRG}{G+1}$. Since the loss introduced by such an attenuator would be (see next page)

Symbols used in text

- G Voltage gain of simple amplifier.
- G' Voltage gain of amplifier with negative feedback.
- $|G'|$ Rationalized gain of feedback amplifier with reactive elements.
- $|G'_{(x)}|$ Rationalized gain with respect to x .
- $|G'_{(0)}|$ Rationalized gain when $x = 0$, i.e. at l.f.
- $|G'_{(\infty)}|$ Rationalized gain, when $x = \infty$ i.e. at h.f.
- k Ratio of maximum to minimum gain in step circuit.
- n Ratio of feedback to input resistor.
- a Real component of impedance.
- b Imaginary component of impedance.
- x measure of frequency, $= \omega CR$
- x_1 The point at which the amplifier gain differs from its l.f. value by 3dB.
- x_2 The point at which the amplifier gain differs from its h.f. value by 3dB.
- Z The impedance of a feedback network, $Z = a + jb$
- Z_{eq} The equivalent two-terminal impedance of a three-terminal network.

$$\frac{\frac{nR}{G+1}}{R + \frac{nR}{G+1}} = \frac{nR}{R(G+1+n)}$$

Then the overall gain is given by

$$G' = \frac{-G \cdot n}{G+1+n} \text{ i.e. the same as eqn. (1).}$$

If now instead of n being purely a numerical factor, it were replaced by Z , where $Z (= a + jb)$ is a complex factor, then the original resistor nR would be replaced by an expression RZ , which could be any complex two-terminal network containing reactive and resistive elements. Hence eqn. (1) now becomes

$$G' = \frac{-GZ}{G+1+Z}$$

Substituting $a + jb$ for Z we have

$$G' = \frac{-G(a+jb)}{(G+1) + (a+jb)}$$

Combining the real and imaginary parts to give the amplitude only of the gain, we obtain

$$|G'| = G \sqrt{\frac{a^2 + b^2}{(G+1+a)^2 + b^2}} \quad \dots \quad (2)$$

This is the basis of the feedback equalizer, but before examining more practical examples there are a few points that should be borne in mind. As stated above, there is an impedance of $\frac{ZRG}{G+1}$ shunting the output, and care should be taken in a practical circuit that this value is much greater than the anode load. Also the grid must have a d.c. return to earth, and this should not be of the same order of magnitude as the a.c. load at the grid ZR

$G+1$ (which will usually be quite low, since the factor $G+1$ will normally be of the order of 100-200 or so). This also means that the input impedance to the circuit is virtually completely resistive and is made up of the input resistor R .

As far as the phase response is concerned this has not been derived, since the ear is incapable of detecting phase errors of the magnitude that would be introduced by these circuits, but as can be seen eqn. (2) should be unconditionally stable for any values of a or b , which is obviously not the case, since if RZ were a parallel tuned circuit the whole would form a Colpitts oscillator! However, such excessive phase-shift elements would not be used for equalizers, and the total error introduced would not amount to more than $\frac{1}{2}$ dB at the most.

To investigate a practical case, let RZ be a single capacitor for case of initial working, as shown in Fig. 4.

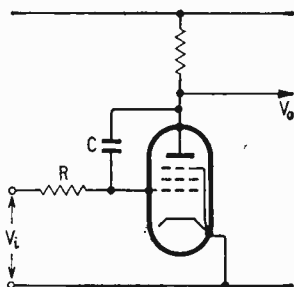

Fig. 4. Simple top cut equalizer.

$$\text{Then } RA = 0 \quad jRb = \frac{-j}{\omega C}$$

$$\therefore a^2 = 0 \quad b^2 = \frac{1}{R^2 \omega^2 C^2}$$

$$\therefore |G'| = G \sqrt{\frac{a^2 + b^2}{(G+1+a)^2 + b^2}}$$

$$= G \sqrt{\frac{\frac{1}{R^2 \omega^2 C^2}}{(G+1)^2 + \frac{1}{R^2 \omega^2 C^2}}}$$

$$= G \sqrt{1 + \frac{1}{\omega^2 C^2 R^2 (G+1)^2}}$$

Putting $\omega CR = x$ (a measure of frequency) we have:—

$$|G'_{(x)}| = \frac{G}{1 + x^2(G+1)^2} \quad \dots \quad (3)$$

Equating $x = 0$ and ∞ in turn gives the l.f. and h.f. gains of this circuit respectively.

$$|G'_{(0)}| = G \quad |G'_{(\infty)}| = 0$$

The l.f. 3 dB point, x_1 , may be obtained by equating

$$|G'_{(x)}| \text{ in eqn. (3) to } \frac{|G'_{(0)}|}{\sqrt{2}}$$

$$\text{i.e. } 1 + x_1^2(G+1)^2 = 2$$

$$\therefore x_1^2 = \frac{1}{(G+1)^2}$$

$$x_1 = \frac{1}{G+1}$$

A widely used combination is a capacitor C in series with a resistor nR .

In this case

$$RZ = nR + \frac{1}{j\omega C} = \frac{jnR\omega C + 1}{j\omega C}$$

$$= R \frac{jnx + 1}{jx}$$

$$\therefore Z = n - \frac{j}{x}$$

$$\therefore a = n \quad b = -\frac{1}{x}$$

$$\text{Hence } |G'_{(x)}| = G \sqrt{\frac{a^2 + b^2}{(G+1+a)^2 + b^2}}$$

$$= G \sqrt{\frac{n^2 + \frac{1}{x^2}}{(G+1+n)^2 + \frac{1}{x^2}}}$$

$$= G \sqrt{\frac{1 + n^2 x^2}{1 + x^2(G+1+n)^2}} \quad \dots \quad (4)$$

If we equate x to 0 and ∞ as before we have

$$|G'_{(0)}| = G \quad |G'_{(\infty)}| = G \sqrt{\frac{n^2}{(G+1+n)^2}} = \frac{G}{k} \text{ (say)}$$

$$\text{where } k = \frac{G+1+n}{n} \quad \therefore n = \frac{G+1}{k-1}$$

Fig. 5. Characteristics of feedback elements

CONFIGURATION	BASIC RESPONSE	a	b	$ G'_{(x)} $	$ G'_{(0)} $	$ G'_{(\infty)} $	x_1	x_2	USES
		n	0	$\frac{Gn}{G+1+n} = \frac{G}{k}$	$\frac{G}{k}$	$\frac{G}{k}$	-	-	REDUCING GAIN TO ACCEPT FREQUENCY-FLAT HIGH-LEVEL SIGNAL
		0	$\frac{1}{x}$	$\frac{G}{\sqrt{1+x^2(G+1)^2}}$	G	0	$\frac{1}{G+1}$	-	INFINITE TOP-CUT CIRCUIT ULTIMATE SLOPE 6dB/OCTAVE
		n	$\frac{1}{x}$	$G \frac{\sqrt{n^2 x^2 + 1}}{n^2 x^2 k^2 + 1}$	G	$\frac{G}{k}$	$\frac{1}{n\sqrt{k^2-2}}$	$\frac{\sqrt{k^2-2}}{nk}$	STEP CIRCUIT OPERATING BETWEEN DEFINED LIMITS MAX. SLOPE OCCURS WHEN $x = \frac{1}{n\sqrt{k}}$ AND MAX. SLOPE IS $20 \log \left(\frac{2k}{k+1} \right)$ dB/OCTAVE
		$\frac{n}{1+n^2 x^2}$	$\frac{n^2 x}{1+n^2 x^2}$	$\frac{G}{\sqrt{n^2 x^2 (k-1)^2 + k^2}}$	$\frac{G}{k}$	0	$\frac{k}{n(k-1)}$	-	SIMILAR TO THOSE USING SINGLE CAPACITOR BUT ACCEPTS HIGHER LEVEL USUALLY USED WITH SERIES CAPACITOR FOR RECORD EQUALIZATION
		n	x	$G \sqrt{\frac{n^2 + x^2}{k^2 n^2 + x^2}}$	$\frac{G}{k}$	G	$\frac{kn}{\sqrt{k^2-2}}$	$n\sqrt{k^2-2}$	USUALLY FOUND ONLY TO EXTEND 'DROOPING' FREQUENCY RESPONSE CAN REDUCE SIGNAL/NOISE RATIOS SHOULD BE USED WITH CARE
		$\frac{n}{1-x^2}$	$\frac{n x}{1-x^2}$	$G \sqrt{\frac{1+x^2}{x^2 (k-1)^2 - x^2 (2k^2-2k-1) + k^2}}$	$\frac{G}{k}$	0	-	-	VERY USEFUL WHERE SHARP PEAK IS REQUIRED eg. IN TAPE RECORD EQUALIZERS

The factor k gives the value of the total lift of this circuit and by its use eqn. (4) may be simplified.

$$|G'_{(x)}| = G \sqrt{\frac{n^2 x^2 + 1}{k^2 n^2 x^2 + 1}}$$

Equating $|G'_{(x)}|$ to $\frac{|G'_{(0)}|}{\sqrt{2}}$ and $|G'_{(\infty)}| \sqrt{2}$ again gives

$$x_1 \text{ and } x_2, \text{ i.e. } x_1 = \frac{1}{n\sqrt{k^2-2}}$$

$$x_2 = \frac{\sqrt{k^2-2}}{nk}$$

The ratio of the two cut-off frequencies is:—

$$\frac{x_2}{x_1} = \frac{k^2-2}{k}$$

Their geometric mean gives the point of maximum slope of the response.

$$\text{i.e. } \sqrt{x_1 x_2} = \frac{1}{n\sqrt{k}}$$

By differentiating the expression for $|G'_{(x)}|$ with respect to x , and substituting $\frac{1}{n\sqrt{k}}$ for x we obtain the value of the

$$\text{maximum slope: } \frac{k-1}{k+1}$$

and hence the maximum slope, in dBs per octave, is:

$$20 \log_{10} \left(\frac{2k}{k+1} \right)$$

The above calculations may be carried out on any two-terminal network to determine its response, as has been done and set out in Fig. 5. More complex networks, while capable of being resolved, tend to become rather cumbersome, and in any case this is not necessary since at any frequency only one capacitor-resistor network is acting, the others being purely resistive or shorted out by low capacitive reactance. Take, for example, the circuit and its response shown in Fig. 6. This is of the type used for record equalization, and consists of four segments. From A to B, the reactance of C_1 is very high and the valve is working at full gain, at B the reactance of C_1 starts to fall as does the gain until point C is reached, at which point the value of R limits the impedance (the reactance of C_2 still being very high).

From C to D the response is flat. At D capacitance C_1 is virtually a short circuit and so it is the parallel combination of R and C_2 that causes the ultimate roll-off at point D. So that for the lower frequencies up to point D the response is caused by a series combination of R and

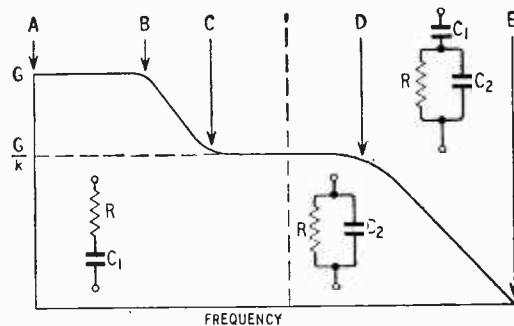

Fig. 6. Synthesis of complex response from simple elements.

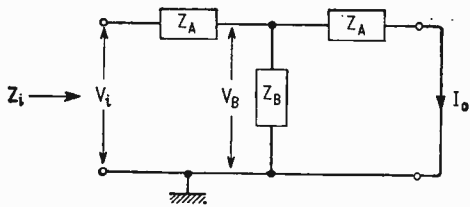

Fig. 7. Simple T-network.

C_1 , while at the higher end the response is governed by a parallel combination of R and C_2 .

So far only two-terminal networks have been considered. However, since it is only the current fed into the input resistor by the output voltage that matters, an equivalent impedance of a three-terminal network may be derived as follows:—

Consider the network shown in Fig. 7. The input voltage V_i is at the output of the feedback amplifier. The output is considered to be short-circuited since the input voltage V_i is G times greater than that at the output.

$$\begin{aligned} \text{Input impedance } Z_1 &= Z_A + \frac{Z_A Z_B}{Z_A + Z_B} \\ &= \frac{Z_A (Z_A + 2Z_B)}{Z_A + Z_B} \end{aligned}$$

$$\therefore V_B = V_i \frac{\frac{Z_A Z_B}{Z_A + Z_B}}{\frac{Z_A (Z_A + 2Z_B)}{Z_A + Z_B}} = \frac{V_i Z_B}{Z_A + 2Z_B}$$

$$\text{Hence } I_o = \frac{V_B}{Z_A} = \frac{V_i Z_B}{Z_A (Z_A + 2Z_B)}$$

so giving the equivalent output impedance

$$\begin{aligned} Z_{eq} &= \frac{\text{Input voltage}}{\text{Output current}} = \frac{V_i}{I_o} \\ &= \frac{Z_A}{Z_B} (Z_A + 2Z_B) \quad \dots \quad \dots \quad (5) \end{aligned}$$

If the Z_A terms in eqn. (5) were equated to $\frac{nR}{2}$ and Z_B were equated to $\frac{1}{j\omega \frac{4C}{n^2}}$ we obtain Fig. 8 (C_1

is large and is only to block the d.c.). Substituting in eqn. (5), we obtain:—

$$\begin{aligned} Z_{eq} &= RZ = \frac{Z_A}{Z_B} (Z_A + 2Z_B) \\ &= \frac{\frac{nR}{2}}{\frac{1}{j\omega \frac{4C}{n^2}}} \left(\frac{nR}{2} + \frac{2}{j\omega \frac{4C}{n^2}} \right) \\ &= \frac{2jx}{n} \left(\frac{nR}{2} + \frac{n^2 R}{2jx} \right) \end{aligned}$$

$$RZ = R(n+jx)$$

$$\therefore Z = n+jx$$

$$\text{i.e. } a = n; b = x$$

$$\therefore |G'(x)| = G \sqrt{\frac{n^2 + x^2}{(G + 1 + n)^2 + x^2}} = G \sqrt{\frac{n^2 + x^2}{k^2 n^2 + x^2}}$$

$$\text{and } |G'(0)| = \frac{G}{k}; \quad |G'(\infty)| = G$$

k again being equal to $\frac{G + 1 + n}{n}$

$$x_1 = \frac{kn}{\sqrt{k^2 - 2}} \quad x_2 = n\sqrt{k^2 - 2} \quad \frac{x_2}{x_1} = \frac{k^2 - 2}{k}$$

It will be seen that this network is the exact inverse of the one previously described, and provides a very useful top lift circuit.

If the output of the above T network were fed back to the output in parallel with that of a similar network, but with the A and B legs interposed, there would be a phase difference between the two outputs and, by choice of frequency and component values, the two currents can be made equal and opposite, in which case they cancel, giving zero output. This gives the method to derive the equivalent impedance of the parallel-T network, and although the method is straightforward, it is also rather laborious, and here I shall only quote the results.

The equivalent impedance of the parallel-T network shown in Fig. 9 is given by:—

$$Z_{eq} = RZ = R \frac{n(1+jx)}{1-x^2}$$

$$\therefore Z = \frac{n(1+jx)}{1-x^2}$$

$$\therefore a = \frac{n}{1-x^2} \quad b = \frac{nx}{1-x^2}$$

$$\therefore |G'(x)| = G \sqrt{\frac{1+x^2}{x^4(k-1)^2 - x^2(2k^2 - 2k - 1) + k^2}}$$

Although this looks rather formidable it will not in practice be the case, as the value of k will be known and the terms will resolve into a simple equation in x^2 .

The 3dB frequencies x_1 and x_2 are not of much use in this type of circuit, and so the $x/2$ and $2x$ gains are given instead, as these are of more practical use.

$$|G'(0)| = \frac{G}{k}; \quad |G'(1)| = G; \quad |G'(\infty)| = 0$$

$$|G'(1/2)| = G \sqrt{\frac{20}{8k^2 + 6k + 5}}$$

$$|G'(2)| = G \sqrt{\frac{5}{9k^2 - 24k + 20}}$$

EXAMPLE

The application of the above data in a practical circuit will illustrate the methods used. Let us assume that we wish to design a pre-amplifier to equalize the response from a tape head used at $7\frac{1}{2}$ i.p.s. to the $100\mu\text{s}$ R.I.A.A. replay characteristic, the output of the head being 5mV at 1kc/s and the output from the pre-amplifier 0.5V r.m.s.

The $100\mu\text{s}$ time constant fixes the upper 3dB roll-off

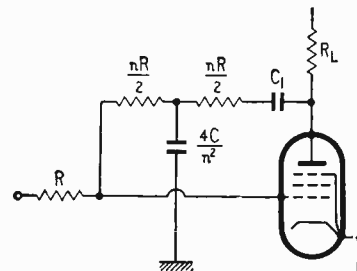

Fig. 8. Top lift circuit.

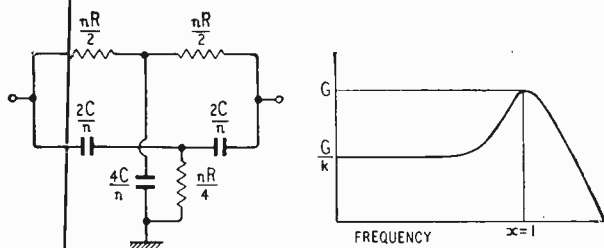

Fig. 9. Parallel T-network and its response.

at 1.6 kc/s and so x_2 corresponds to this frequency. Assuming the head is good enough to have a response extending down to 32 c/s we will fix this frequency as the x_1 point.

$$\begin{aligned} \therefore \frac{x_2}{x_1} &= \frac{1600}{32} = 50 = \frac{k^2 - 2}{k} \\ \therefore k^2 - 50k - 2 &= 0 \\ \therefore k &\approx 50 \end{aligned}$$

If an EF86 valve is used with a 220kΩ anode load the gain will be 100.

$$\begin{aligned} \therefore n &= \frac{G + 1}{k - 1} = \frac{101}{49} \\ &\approx 2 \end{aligned}$$

$$\begin{aligned} \therefore |G'(x)| &= G \sqrt{\frac{n^2 x^2 + 1}{x^2 n^2 k^2 + 1}} \\ &= 100 \sqrt{\frac{2^2 x^2 + 1}{2^2 \cdot 50^2 x^2 + 1}} \\ &= 100 \sqrt{\frac{4 x^2 + 1}{10^4 x^2 + 1}} \\ &\approx 100 \sqrt{\frac{4 x^2 + 1}{10^4 x^2}} \\ &= \frac{1}{x} \sqrt{4 x^2 + 1} \end{aligned}$$

Also $x_2 = \frac{\sqrt{k^2 - 2}}{nk} = \frac{\sqrt{2500 - 2}}{2 \cdot 50} \approx 0.5 = 1.6 \text{ kc/s}$

Hence the value of x corresponding to 1 kc/s is:—

$$x (1 \text{ kc/s}) = 0.5 \times \frac{1}{1.6} = 0.313$$

$$\therefore |G'(0.313)| = 3.2 \sqrt{(4 \times 0.084) + 1} = 3.7$$

$$\therefore \text{Output of 1 kc/s} = 5 \times 3.7 \text{ mV} = 18.5 \text{ mV}$$

Since an output of 500mV is required, the equalizer should be preceded by an amplifier of gain:—

$$G = \frac{500}{18.5} = 27$$

An EF86 triode connected with an anode load of 100kΩ gives a gain of 27.5 according to the Mullard Data Sheets, and should also provide a good low noise configuration.

Since at 1.6 kc/s $x = 0.5$; $x = 1$ at 3.2 kc/s, therefore

$$RC = \frac{1}{\omega} = \frac{1}{2\pi \cdot 3,200} = 50 \mu\text{s}$$

i.e. the product of the input resistor R and the feedback capacitor in megohms and microfarads equals 50×10^{-6} . Such a combination is 100pF and 500kΩ. This gives the equalizer an input impedance of 500kΩ which will

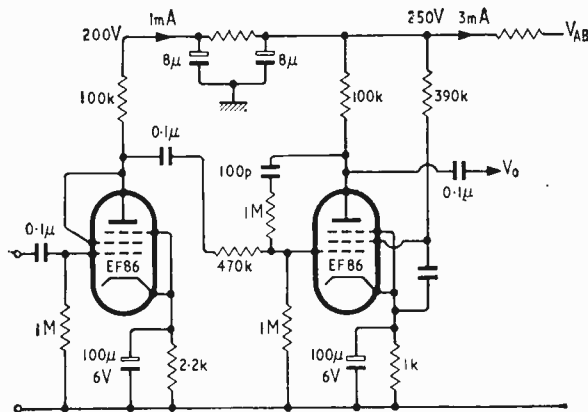

Fig. 10. Tape pre-amplifier, equalized for 7½ i.p.s.

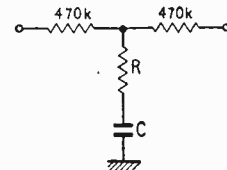

Fig. 11. Step circuit for limited top boost in Fig. 10.

not load the 100kΩ anode load of the preceding stage, and since $n = 2$, the load effectively in parallel with its own anode load is $2 \times 500k\Omega = 1M\Omega$.

The feedback resistor is given by:

$$nR = 2 \times 500 = 1M\Omega$$

It must be borne in mind, however, that the 500kΩ series resistor includes the output impedance of the previous stage, in this case the 100kΩ anode load and the anode impedance in parallel, the latter in the triode connection being 33kΩ.

Hence the total output impedance is

$$\begin{aligned} &= \frac{100 \times 33}{100 + 33} \\ &= 24.7k\Omega \end{aligned}$$

therefore the actual value of series resistor needed

$$\begin{aligned} &= 500 - 24.7k\Omega \\ &= 475.3k\Omega \end{aligned}$$

i.e. in practice a 470kΩ resistor.

The d.c. conditions are again obtained from the Mullard Data Sheets, and the complete circuit is given in Fig. 10.

When such an amplifier has been constructed it may be found that a slight modification to the frequency response is needed. A step in the response with flat response on either side of the step denotes an error in the choice of the frequency of a roll-off. The ratio of the response above and below the step is the same as the correct and actual cut-off frequencies. If in a circuit such as Fig. 10 the response at the h.f. end needs boosting this may be done by modifying its 1MΩ feedback resistor as shown in Fig. 6. to the T-network shown in Fig. 11. The value of R is chosen to raise the equivalent impedance from $2 \times 470k\Omega$ to the value needed to provide the amount of top boost required. The value of the capacitor determines the frequency at which the boost occurs.

From the above it can be seen that the design of equalizers is not difficult, and by cascading simple equalizer elements, complex response shapes may be constructed, either with the network given in the table or with others.

NEW PRODUCTS

SEEN AT RECENT LONDON SHOWS

THE Radio & Electronic Component Manufacturers' Federation having maintained its "British only" attitude for the biennial London Component Show, a number of smaller exhibitions mainly of overseas equipment are now held during the same period (May 23-26 this year). We have, therefore, included in this section not only new products selected from those shown by the 300-odd exhibitors at Olympia but also several items from the other shows.

In doing this we are in no way wishing to belittle the efforts of the British industry which in its last report (1966/7) recorded an increase of about 8% over the previous year's output. It is, however, interesting to

note that in 1966 the imports of components and accessories rose by 20% to £19.6M whereas exports rose by 17% to £49M. These figures do not include valves, tubes and semiconductors (imports of which rose by 30% to £18.3M and exports fell by 1% to £14.6M) nor test equipment (imports fell by 30% to £200,000 and exports by 20% to £1.2M).

The organizer's report on the R.E.C.M.F. Show records that despite the fact that the period of the exhibition immediately preceded the Spring holiday (which was announced after the dates of the Show had been fixed) the attendance of over 59,000 was some 4,000 up on the 1965 figure.

500-W 500-Mc/s Tetrode

A HIGH-GAIN beam tetrode for use as a power amplifier up to 500 Mc/s is introduced by the M-O Valve Co. It is intended for use in mobile equipment. The valve, designated G.E.C. type E3107, is of cylindrical ceramic-metal construction. Conduction cooling is provided for by a 2 in dia. flange for clamping to a suitable heat sink. This arrangement gives rise to a total output capacitance of 7.5 pF. Anode dissipation depends on heat sink temperature and for 100°C 500 W may be dissipated. Maximum anode voltage is 2.5 kV and peak cathode current is 2 A. For an anode potential of 1 kV and a current of 250 mA, g_m is 28 mA/V. Typically the valve can provide 260 W at 7 Mc/s

(class AB) and 84 W at 100 Mc/s when driven by a 2N3553 self-oscillating driver. For class C operation up to 600 W can be delivered with maximum anode potential. It is suggested that for u.h.f. operation the heater voltage is reduced from 6 to 5.75 V for 300-400 Mc/s and to 5.5 V for 400-500 Mc/s to ensure maximum life. Heater current is 3.25 A. M-O Valve Co. Ltd, Brook Green Works, London, W.6.

WW 301 for further details

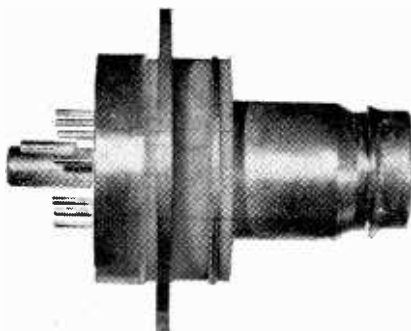

Solid Iron Cores

TWO-PIECE cores designed to take the place of standard E and I laminations are to be produced by Linton and Hirst Ltd, Stratton St. Margaret, Swindon, Wilts. The advantage stated for these cores include reduced assembly time, and better iron loss and magnetizing current characteristics than a fully interleaved stack of laminations with identical dimensions. Types to be initially available from 1st September, are stacks corresponding to the MAXICON range up to pattern 248A in size. Electrical characteristics data are available.

WW 302 for further details

M.O.S. "BREADBOARDING" I.C.s

PLESSEY are introducing a range of what they call "bread-boarding" i.e. elements based on the m.o.s. field-effect transistor technology. The idea is that the customer can assemble a number of these elements to form a prototype system and then return it to the company (Semiconductor Division, Cheney Manor, Swindon, Wilts), who will convert it into a completely integrated circuit on a single semiconductor chip. One part of this range, the ML100 series, is a group of analogue switches consisting of various combinations of matched p-channel enhancement-mode m.o.s. field-effect transistors: a single device for use as a chopper, a matched pair of devices, two common-source pairs, and a set of six common-source devices. They can also be used as multiplexers. The remainder of the range, the MP100 and MP200 series, consists of m.o.s. logic elements, and includes NAND and NOR gates, an OR/NOR gate and a counter/register. The most complex logic element, a 24-bit shift register, illustrates the amount of circuitry which it is economically feasible to get on to one chip at present. Encapsulations are TO-5, TO-18 or flat packs.

WW 303 for further details

Thick Film Circuits

THICK film components and integrated circuits are now produced by a number of manufacturers, e.g. S.T.C., Welwyn, Morganite, Centralab, and A.B. Metal Products. Thick film circuits, unlike thin film circuits which use evaporation techniques, are produced by a process similar to screen printing. Using thick film production methods resistors from $1\ \Omega$ to $1\ \text{M}\Omega$ can be fabricated and capacitors of $0.5\ \mu\text{F}$ to $2.2\ \mu\text{F}$. Active devices can be attached by the inverted leadless technique. The illustration shows a Morganite network of resistors with values varying from $25\ \Omega$ to $1\ \text{M}\Omega$ with values adjusted to within 2%. Welwyn showed a new range of low-cost hybrid integrated circuits in the form of logic and linear modules. Dual in-line packages are used measuring $0.08\ \text{in}^3$ volume. The logic range are medium speed aimed at industrial data processing and control systems and includes dual 3-input NAND/NOR gate, the three types of multivibrator, half adder, and buffer amplifiers. Operational amplifiers are the first items in the linear range. Cost of the logic gates is given as around 3/-.

WW 304 for further details

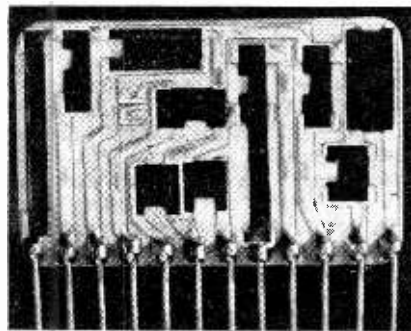

Automatic Battery Charger

ALL models in the Astralux range of battery chargers are fitted with input/output fuses and mains indicator light. The A30/28/BC is a series A charger with battery compartment for two 6V 60Ah cells. It provides an output of 12V d.c. $\pm 3\%$ at 1A, for an input of either 200, 220, or 240V $\pm 10\%$ 50c/s. Three chargers in the B series will all function with an input of either 200, 220 or 240V $\pm 10\%$ 50c/s. The outputs of the B120/46/BC, B120/29/BC and the B120/15/BC are 6V d.c. $\pm 5\%$ at 3A, 12V d.c. $\pm 3\%$ at 3A, and 24V d.c. $\pm 3\%$ at 3A respectively. Astralux Dynamics Ltd., New Street, Brightlingsea, Colchester, Essex.

WW 305 for further details

WIRELESS WORLD, JULY 1967

Conventional-Digital Typewriter Conversion

AN interesting and ingenious method of obtaining a digital output from a standard typewriter was demonstrated by the National Physical Laboratory. The device takes the form of a simple add-on unit that does not necessitate any mechanical alteration to the typewriter with the possible exception of the provision of mounting facilities. Coded markers on the side of each hammer are read by a five channel photo-diode reading head, the output of which feeds a simple storage device. The hammers are coded by first painting the side of each hammer with matt black paint which is allowed to dry and then "scratching in" the required code by removing portions of the paint. The presence of a hammer



in the reading position, just before it strikes the platen, is sensed by two further photo diodes that scan the uncoded side of the hammer, the outputs of these two diodes enable the input to the store via a simple logic circuit. The prototype used the standard ISO code but any code could be incorporated and could be changed at any time by simply re-painting and re-scratching the hammers.

WW 306 for further details

Shrinkable Plastic Tubing

RADIATION-CHEMISTRY techniques can impart the property of elastic memory to certain plastic materials and this has resulted in a range of shrinkable plastic products for electronic applications. In the Thermofit range of extruded tubing, for example, the plastic is subjected to electron beam radiation which causes crosslinking of its molecular structure. The tubing is then expanded and supplied in this form.

When heated, because of its elastic memory, this tubing will shrink to its original size. Thermofit is available in a wide range of modified plastic materials, and it is stated that it offers good electrical insulation, mechanical protection and strain relief in many applications.

Other products are moulded parts and solder sleeves. Raychem Ltd., Cheney Manor, Swindon, Wiltshire.

WW 307 for further details

E.H.T. Measurement

SUITABLE for measuring the e.h.t. voltage of colour television receivers is the "high-voltage d.c. multiplier" just introduced by Avo Ltd., of Avocet House, Dover, Kent. Actually a potential divider constructed from carbon and metal-film resistors, it enables voltages in the ranges 0-10kV or 0-30kV to be measured by any multi-meter with a 10V f.s.d. range and a sensitivity of $20,000\ \Omega/\text{V}$ (Avometer Models 8 and 9 and Test Set (High Sensitivity No. 1 can be used). The voltage source to be measured is connected by a special lead to one of the two e.h.t. terminals—10kV or 30kV—as appropriate, the other terminal being covered by a protective cap, and the multimeter, switched to its 10V range, is connected to a pair of low-voltage terminals. A resistor is shunted internally across these terminals to limit the voltage across them to 20V when the multimeter is disconnected. A third

terminal near the meter terminals goes to an internal electrostatic screen inside the base of the multiplier.

WW 308 for further details

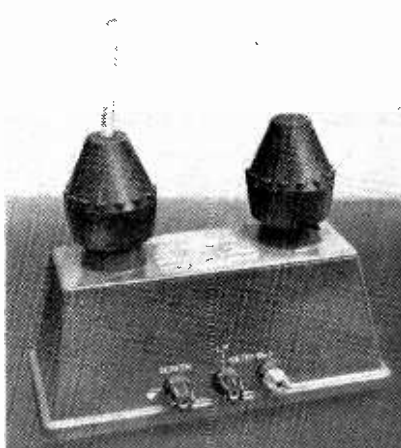

Domestic Equipment I.Cs

THE heart of a domestic sound receiver—oscillator/mixer, i.f. amplifier, detector, low-power a.f. amplifier—can be provided in one small package by the 530M linear integrated circuit shown by Mullard Ltd., of Mullard House, Tor-

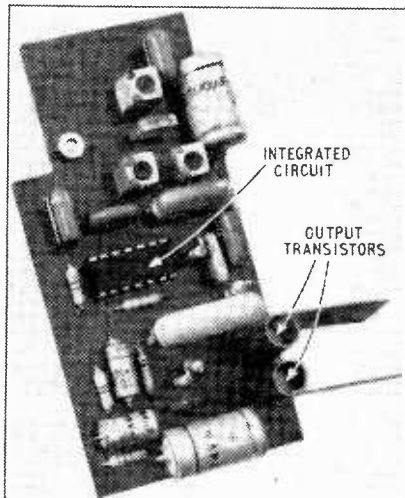

rington Place, London, W.C.1. The makers demonstrated it in two slightly different applications—in a medium-wave portable receiver and in the f.m. inter-carrier sound channel of a 625-line television receiver. In the medium-wave portable, which was powered from a 9 V battery, the i.c. replaced five conventional transistors and two diodes, and the only discrete active devices used in addition to it were two transistors in the push-pull output stage. The i.c. is housed in a 14-lead flat pack.

Another linear i.c. shown by the company was an audio amplifier which uses an m.o.s. field-effect transistor in the first stage to achieve the high input impedance of $10^{11} \Omega$ and so is suitable for crystal pickup input. Following the m.o.s.t. is a bi-polar transistor, which makes the device compatible with other bi-polar transistor stages. Designated 320TAA, the i.c. is housed in a TO-18 can and requires a 20 V drain-source supply for the m.o.s.t. The frequency response of the complete amplifier is said to be substantially flat from 50 c/s to 15 kc/s.

WW 309 for further details

Diode-tuned TV Tuners

COMPACT u.h.f. and v.h.f. tuners intended mainly for television receivers are manufactured by Hopt Electronics Ltd., of Bull Hill Industrial Estate, Clacton-on-Sea, Essex. The new company is German based and the distributors are G.E. (Electronics) Ltd., of 184, Campden Hill Road, London, W.8. The u.h.f. tuner (type 127/60) measures about $65 \times 25 \times 40$ mm and contains AF239 and BF161 transistors and three BA139 or BA141 capacitance diodes. Diode voltage variation of 1.5 to 30 V gives coverage from 470 to 790 Mc/s for an i.f. of about 36 Mc/s. Power gain of 10 dB is available at mid-frequency. The v.h.f. TV tuner covers both bands I and III and uses an

AF109 (grounded base amplifier) and two AF106s (oscillator and mixer). The AF106 mixer acts as an i.f. amplifier when used in conjunction with a u.h.f. tuner. When u.h.f. reception is required, the v.h.f. oscillator is switched off, the signal applied via a forward-biased BA152 or BA136 switching diode and the v.h.f. tuned circuits are disconnected by a second switching diode. Band I-III switching is carried out by magnetically operated reed switches, and tuning is with three BA138 diodes. Channel selection can be carried out by use of a push-button potentiometer unit also manufactured by the company.

WW 310 for further details

V.H.F. Power Transistors

RADIO frequency outputs of 2.5 to 25 W in the v.h.f. band can be obtained from silicon epitaxial planar power transistors developed in the U.K. by Texas Instruments and now being produced at their Manton Lane, Bedford, factory. They are constructed with inter-digitated emitter and base stripes, and the design allows a multiplicity of signal inputs, so improving current distribution and eliminating hot spots, and gives a minimum voltage drop along the individual stripes so that all the emitter periphery

is effective. The 2N3632, for example, with a supply line of 28 V, will give 20 watts output at 100 Mc/s or 13.5 W at 175 Mc/s, the f_T being 450 Mc/s. Others in the range are the XB401 (2.5 W at 175 Mc/s), 2N3375 (7.5 W at 175 Mc/s), XB404 (10 W at 175 Mc/s) and XB408 (25 W at 175 Mc/s). All operate typically with $V_{ce} = 28$ V and all are housed in TO-60 cans except the XB401 which has a TO-39 can.

WW 311 for further details

High-quality Focus Coil

AN ELECTROMAGNETIC lens for cathode-ray tube displays which can focus an electron beam to a spot size of 0.02 cm was announced by Marconi Co. The focus unit is made of several annular sections comprising three alignment coils, two astigmatism correction coils and two focusing coils. Thermistors are used with the alignment and astigmatism connection coils to compensate for temperature changes over the range -10 to 70 deg C.

It can be used with all types of magnetically focused c.r.t.s with neck diameters up to 3.5 cm. The focus coil is intended for radar and tabular displays.

WW 312 for further details

100 M/cs 3.5 ns Scope

TYPE 647A ruggedized oscilloscope was featured by Tektronix. In conjunction with 10A2A dual-trace plug-in unit response extends from d.c. to 100 Mc/s with 3.5 ns risetime. Most sensitive vertical range is 10 mV/cm. For greater sensitivity, the two channels may be cascaded giving 1 mV/cm and a bandwidth of 30 Mc/s. A delayed-sweep time-base unit triggers to 100 Mc/s and provides a calibrated delayed sweep. Calibrated sweep range is from 10 ns/cm to 5 s/cm. Single sweep operation is also possible. An accelerating potential of 14 kV provides a bright display and the viewing area (6×10 cm) incorporates a non-parallax internal graticule. The oscilloscope is also available in a rack mounting version. Tektronix UK Ltd., Beaverton House, Station Approach, Harpenden, Herts.

WW 313 for further details

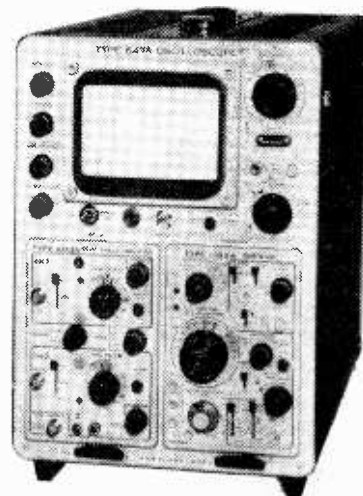

WIRELESS WORLD, JULY 1967

Vortexion quality equipment

TYPE C.B.L. TAPE RECORDER

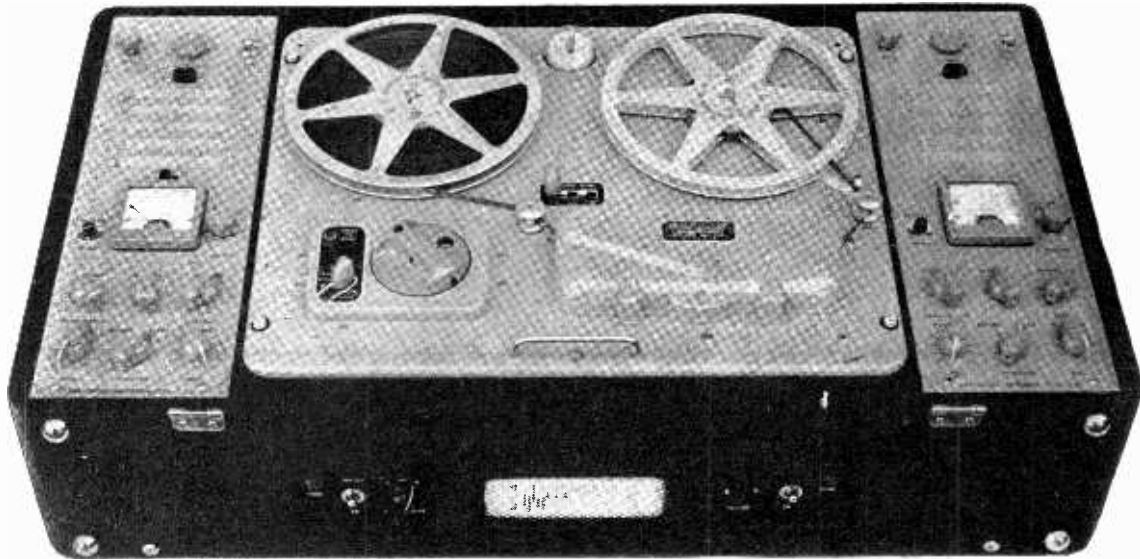

Here is a versatile stereophonic recorder which has no equal in its price group.

IT CAN record monaurally or stereophonically with its own mixed inputs from Gram, Radio or other sources and from high grade low impedance balanced line microphones. With good microphones, etc., the result is a suitable master for disc manufacturers. "Before and After" monitoring is provided together with adjustable metered bias for perfection.

IT CAN also make a recording on one track and then transfer it to the other track while measuring and listening to it and adding one or two more signals also metered. A special PPM type meter is now used.

IT CAN repeat the process and transfer this combined signal to the first track with one or two more signals. Composers use it for this purpose. One track may have music or commentary and the other cueing signals or commentary and either may be altered without the other.

IT CAN playback stereophonically or monaurally with its own amplifiers of $3\frac{1}{2}$ watts each.

Speeds $1\frac{7}{8}/3\frac{3}{4}/7\frac{1}{2}$ i.p.s. Price **£172 0s. 0d.**

Speeds $3\frac{3}{4}/7\frac{1}{2}/15$ i.p.s. Price **£180 0s. 0d.**

The Vortexion W.V.B. is a high quality monaural machine with "Before and After" monitoring. The recording inputs are a high sensitivity socket for moving coil or ribbon microphone and a high impedance socket for radio, etc., either of which can be selected by a switch. Superimposing and echo work can be done and the playback has reserve gain for abnormal requirements. This model cannot be converted for stereo playback, but it is a thoroughly reliable machine for the engineer specialising on monaural work.

Speeds $1\frac{7}{8}/3\frac{3}{4}/7\frac{1}{2}$ i.p.s. Price **£115 10s. 0d.**

Speeds $3\frac{3}{4}/7\frac{1}{2}/15$ i.p.s. Price **£128 0s. 0d.**

The Vortexion W.V.A. is a monaural machine which has a performance equal in sound quality to the other models. It possesses all the features of the W.V.B. except for "Before and After" monitoring, Dubbing and Echoes. The recording being made can be heard on the internal loudspeaker as in the W.V.B. and C.B.L. The controls are uncomplicated.

Speeds $1\frac{7}{8}/3\frac{3}{4}/7\frac{1}{2}$ i.p.s. Price **£96 7s. 0d.**

Speeds $3\frac{3}{4}/7\frac{1}{2}/15$ i.p.s. Price **£107 3s. 0d.**

All tape recorders have adjustable bias controls, low impedance mic. inputs for unlimited lengths of cable, highly accurate position indicators and meters to measure recording level and bias.

VORTEXION LIMITED, 257-263 The Broadway, Wimbledon, S.W.19

Telephone: LIBerty 2814 and 6242-3-4

Telegrams: "Vortexion London S.W.19"

WW—091 FOR FURTHER DETAILS

POWER SUPPLIES FROM ETHER... OFF THE SHELF

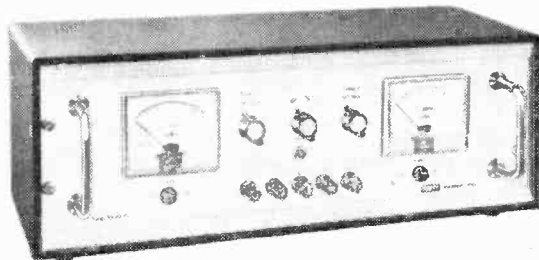

TAYN Series
Continuously variable
twin outputs at 0.5A,
1A, 2A; 0-30V

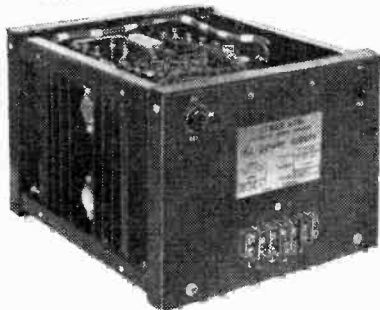

Series KK
Single-output preset
units at 5A, 10A,
15A, 20A, 30A; 0-50V



ABM Series
Continuously variable
single outputs at 0.5A,
1A, 2A; 0-30V

A SMALL SELECTION FROM THE LARGEST RANGE IN EUROPE

— and we make 'specials' to order

Stabilisation ratios up to: 10,000:1

Typical ripple down to: 200 μ V p/p

Output resistance down to: 0.002 Ω

“ TALK POWER SUPPLIES WITH ETHER ”

ETHER

Ether Limited, General Products Division, Caxton Way, Stevenage,
Herts. Telephone Stevenage 4422. Telex Ether Stevenage 82319.

Nanosecond I.C. Logic

THREE new logic elements have been added by Mullard to their high-speed integrated-circuit range E²CL, which is intended for operating at clock-pulse rates up to 100 Mc/s with pulse edges of 2 ns or less. The FKH131 is an 8-input gate with two outputs, one of which, X, gives (in Boolean notation), $X = A.B.C.D.E.F.G.H.$ while the other, Y, gives $Y = A.B.C.D + E.F.G.H.$ The second element, the FKH171, also has eight inputs and gives one output, $X = A.B.C.D + E.F.G.H.$ but although it is apparently less versatile than the FKH131 it has the advantage of having a consistent switching time regardless of the input activation pattern. The third element, the FKH161, is a 6-input gate with two logically identical but electrically isolated output pairs—each pair consisting of one AND and one NAND output. All elements, which are in 14-lead flat packs, operate from a 4V supply and have 75-Ω input and output impedances. E²CL is an improved form of current-steered logic using basically a long-tailed pair of transistors (emitter coupled) as a switching device, with emitter-follower input transistors and an emitter-follower providing a reference voltage for the mid-point of the logic voltage swing

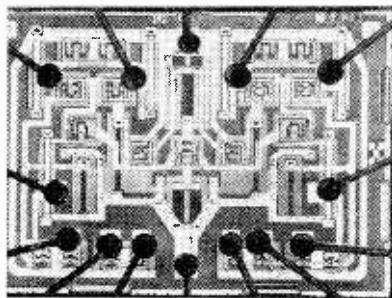

(0V to -0.7V). The high speed of switching is mainly due to the non-saturating mode of operation (no hole storage) and to the smallness of the input capacitance resulting from the use of the emitter-follower input transistors. In systems, to preserve the 2 ns pulse edges and avoid spurious switching actions, it is necessary to design the interconnections between elements as impedance-matched transmission lines. To illustrate this Mullard demonstrated a system (a test equipment for a thin-film store) in which E²CL elements were interconnected by 75-Ω strip lines formed by printed-circuit technique.

WW 319 for further details

STROBOSCOPE

THE type 4910 stroboscope has been introduced by Brüel and Kjaer for use when it is desired to analyse the behaviour of equipment in motion. In its normal operating mode the stroboscope is triggered by the object's movement via a suitable form of transducer ensuring

exact synchronism. The "frozen" image can be positioned anywhere in the motion cycle by means of a phase knob. The input signal can also be added to an internal oscillator (Δf) that is adjustable from 0.5 to 2 c/s and the flashes synchronized with the resultant signal, this has the effect of slipping the motion so that the movement may be observed at a frequency of Δf . The input trigger signal should be within the limits 100 mV-280 V p-p with a minimum pulse width of 20 μ sec; the input impedance is 31.5 k Ω . An internal oscillator may be used to provide flashes between 5 and 105 c/s. The range of the unit when triggered from an external source is 5 c/s-10 kc/s. The type 4910 is available from B & K Laboratories Ltd., 4 Tilney Street, London, W.1.

WW 320 for further details

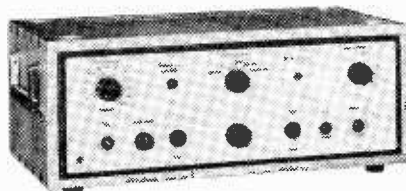

MINIATURE MAINS TRANSFORMER

DIMENSIONS of the Belclere miniature transformer ES2818 are $1\frac{1}{2} \times 1 \times \frac{3}{4}$ in. With a weight of $1\frac{1}{2}$ ounces this transformer is available in several mountings such as printed circuit pins, wrap-over clamp, or completely screened in Mumetal. Finishes can be either a thermosetting varnish, epoxy resin, or high melting point wax. A typical application of this particular component is for re-charging an 11.4 V, 500 mA hour capacity DEAC battery in approximately 14 hours. Primary is 240 V at 50 c/s, secondary is 12-0-12 V. The Belclere Co. Ltd., Cowley Road, Oxford.

WW 321 for further details

MONOLITHIC TRANSISTORS

A NEW range of monolithic dual transistors, the 2N4042 series, that have been developed by Union Carbide Ltd. are now available from Livingston Components Ltd., Greycaines Road, Watford, Herts. Because of the monolithic structure the devices exhibit very good thermal and transient tracking capabilities. The transistors are housed in TO-5 or TO-18 cans, and an enlarged cross-section of one is shown in the photograph. Some extracts from the specification are a base voltage differential change of $3 \mu\text{V}/^\circ\text{C}$ between -55 and $+125^\circ\text{C}$ and a base current differential change of $0.3 \text{ nA}/^\circ\text{C}$ in the same temperature range. With a collector current of $10 \mu\text{A}$ the minimum current gain is 200 and output capacitance does not exceed 0.8 pF when $V_{ce} = 5 \text{ V}$.

WW 322 for further details

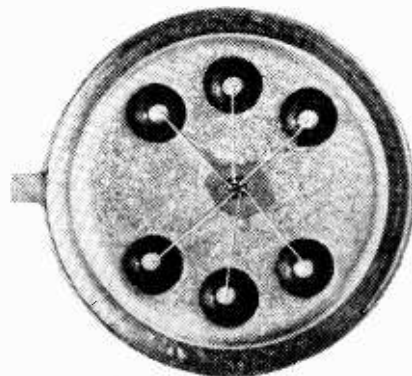

Instrument Cases

CASES in the DE range by Datum are constructed of press formed and welded sections in 18 s.w.g. zinc-coated steel. Zinc-based alloy diecastings to BSS 1004A are used in the corner sections to ensure a rigid structure. These cases will accept 19 inch panel mounted equipment, and of the eleven sizes in the range, eight will accept chassis 11×16 in deep, and the three larger sizes will take 19 in deep rack mounted equipment. Ventilation is through multipunched slots in the base and the rear panel. The overall dimensions range from $20\frac{3}{8}$ width, $23\frac{1}{8}$ height and $12\frac{3}{4}$ depth (inches) to $20\frac{3}{8}$ width, $55\frac{1}{8}$ height, and $21\frac{1}{8}$ depth (inches). Standard finishes are silver grey or silver blue hammer. Bedco Ltd., Datum Metal Products Division, Colne Way Trading Estate, Watford By-Pass, Watford, Herts.

WW 323 for further details

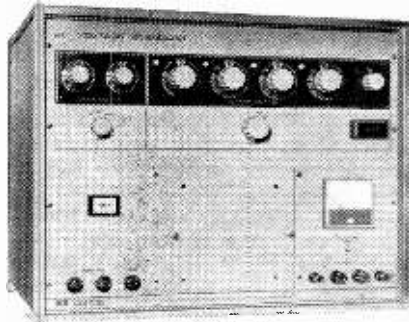

A.C. Voltage Standard

THE type 3102 a.c. solid state voltage standard announced by Dynamco Ltd., Dynamco House, Hanworth Lane, Chertsey, Surrey, provides outputs of 100 μ V to 1011.1 V r.m.s. between 40 c/s and 10 kc/s at the lower of either 50 VA or 1 amp. Output voltage is adjusted by means of inductive dividers with an absolute accuracy of 0.02% of range setting including all errors caused by distortion, ambient temperature variations between 10 and 40°C and long term drift. The internal oscillator can be set to an accuracy of 1% by means of a two-digit switch and a three-decade multiplier; if it is desired an external oscillator may be used. The linearity of the output voltage settings at mid-band frequencies is 0.0015% between ranges relative to the one volt range, and drift due to temperature variation is less than 0.0006% of the output voltage per 1°C in the range 10 to 40°C. A meter indicates either maximum permissible loading or the condition of the internal control loop.

WW 324 for further details

Industrial n-p-n Transistor

THE SGS-Fairchild C428 silicon planar n-p-n transistor is a low-priced, low to medium power unit suitable for a wide range of industrial applications. Maximum collector-emitter voltage rating is 30 V and collector currents of up to 100 mA are permissible. At 1 mA and 100 mA h_{FE} is typically 100, rising to 160 at 25 mA. Dissipation at 25°C ambient is 800 mW rising to 5 W at 25°C case temperature. Saturation voltage at 10 mA is 0.15 V and 0.9 V at 100 mA. 100-up price is 2s 6d. SGS-Fairchild Ltd, Planar House, Walton Street, Aylesbury, Bucks.

WW 325 for further details

Frequency Meter/Counter-timer

THE TSA6636 shown by Venner Electronics Ltd., Kingston By-Pass, New Malden, Surrey, is a general-purpose instrument that will measure frequency from 10 c/s to 12.5 Mc/s and time intervals from 1 μ s to 10⁷ s. Frequency is measured by counting cycles during known time intervals, and the gating times available for determining these intervals range from 1 μ s to 10⁷ s in decade steps. Time intervals are measured by counting the number of known clock units that occur during an interval (determined by gating from external start and stop pulses) and the units available again range from 1 μ s to 10 s in decade steps. The upper limit of 10⁷ seconds is fixed by the six-digit display (provided by in-line neon number tubes). In addition the instrument can be used as a gated counter (range: 10 c/s to 12.5 Mc/s) and for measuring periods of repetitive functions with frequencies from 10 c/s to 1 Mc/s. A single period of a function can be



measured using time units ranging from 1 μ s to 10 Mc/s in decade steps; or multiple periods, from 1 to 10⁷, can be measured using the 1 μ s time units only. The internal time units are derived from a 2 Mc/s oven-controlled crystal with a stability of ± 1 part in 10⁶, and the accuracy of the instrument is ± 1 count \pm this stability. Display time is variable from 0.5 to 5 s or can be infinite.

WW 326 for further details

STC Plastic Semiconductor Devices

AMONG the new silicon devices from S.T.C. Semiconductors Ltd., of Footscray, Sidcup, Kent, are plastic diodes, encapsulated transistors, and thyristors. The first four plastic transistors are types BC171, BC172, BC173 and BC192, the first three being electrical equivalents to the BC107, BC108 and BC109 respectively. The thyristors are in 1 A (TE1 series) and 3 A (TE3 series) ranges with voltage ratings of up to 400 V. A 1 A range is also available for d.c. applications

where no reverse voltage is applied (TE1F).

Plastic rectifiers are also announced with reverse voltage ratings of up to 1,000 V and with a mean current rating of 1 A (1N4003-7). Two new plastic diodes are introduced which have a low series resistance (0.5-1 Ω) and inductance (2 nH) making them suitable for band-switching up to frequencies of 1 Gc/s (BA143).

New transistors with Pro-electron

codes are summarized in the table. In addition to the tabulated types a number of established 2N types are now available:—2N918, 2N2217, 2N2218 (complementary to BSX40), 2N2217 (complementary to BSX41), 2N2904-5, 2N3299 and 2N3300. Other recent additions are 2N3724-5, 2N3962 and 2N3964 (complementary to BC107-9), 2N4030-3 (complementary to BSY81-6) 2N4046-7.

WW 327 for further details

Device	$V_{CE}(V)$	$I_C(A)$	$P_{tot}(W)$	h_{FE}	$f_T(Mc/s)$	Application
BD106	36	2.5	11.5	A 50-150 B 100-300	100	a.f. output
BD107	64	2.5	11.5	A 50-150 B 100-300	100	a.f. output
BDY15	36	2.5	11.5	A 50-150 B 100-300 C 200-600	100	power switching
BDY16	64	2.5	11.5	A 50-150 B 100-300	100	power switching
BF117	140	100mA	1.27*	25 min	80 min	Video amp
BF167	30	25mA	130mW†	—	350	a.g.c. tv i.f. amp
BF173	25	25mA	200mW†	—	550	tv i.f. amp
BLY15A	64	2	11.5	20 min	180	r.f. amplifier
BSX40	30	0.5	600mW	40-120	100	switching
BSX41	30	0.5	600mW	100-300	150	switching

† Ambient temperature 45°C

* Case temperature 100°C

I.C. in Leadless Inverted Package

ONE of the techniques by which semiconductor chips can be mounted on film circuits is the so-called LID (Leadless Inverted Device) package, but hitherto this has been restricted to single devices such as transistors. At the exhibition, Transistron Electronic were showing an example of an integrated circuit chip mounted into such a package—actually a digital circuit from their t.t.l. (transistor-transistor logic) family of i.c. logic elements which are normally in 14-lead flat packs. The package, which is made of alumina filled ceramic, is bigger than the LIDs used for single devices (approx. 0.16in square) and has seven contacts on each side. These contacts, of course, are soldered on to the film circuit after the device has been inverted on to it. The i.c. (shown exposed in the picture) is actually encapsulated in the ceramic block

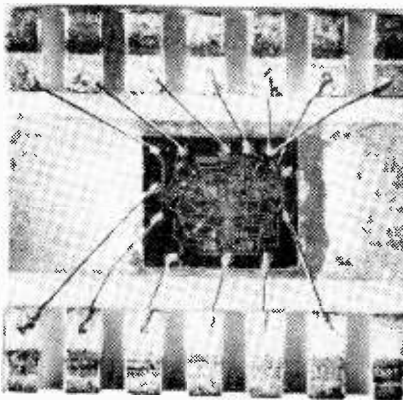

by epoxy resin. Later Transistron (Gardner Road, Maidenhead, Berks) hope to extend the LID technique to linear integrated circuits.

WW 328 for further details

Sweep Generators

TELONIC INSTRUMENTS demonstrated a new range of sweep generators suitable for a wide variety of applications. For the rapid production alignment of television receivers the type 1011 (v.h.f.) and the types 1005 and 1006 (u.h.f.) are available and can be fitted with a variety of optional extras. The v.h.f. version covers the range 5-250 Mc/s and its Varicap sweep system will cover 5-30 Mc/s in a single sweep. Several alternative marker systems can be fitted to customers' requirements and a feature known as "Autotrack" enables the generator to centre automatically on the tuner centre frequency. The u.h.f. version cover 450-910 Mc/s and employs a varactor sweep oscillator. The model 2003 is a sweep system that will cover to 1500 Mc/s by means of five plug-in oscillators. Markers are obtained from plug-in units that will provide a number of single frequency,



harmonic type and variable marker combinations. A marker time sharing facility is also available which minimizes interference between markers that are close together. The optional display processing unit enables markers to be tilted so that they may be clearly seen on a steep skirted response. Telonic Industries U.K., The Summit, Castle Hill Terrace, Maidenhead, Berks.

WW 329 for further details

Cheap I.C. Amplifiers

AN integrated-circuit d.c. amplifier with a gain of 70 dB and priced at only 17s 6d was announced at the exhibition by Plessey (Components Group, Semiconductor Division, Cheney Manor, Swindon, Wilts). Designated SL.701C and encapsulated in an 8-lead TO-5 can, it is actually a lower grade version of the more expensive SL.701 from the company's SL.700 series of d.c. amplifiers. Incorporated in the circuit is a balanced comparator input stage with an auxiliary balancing circuit to

keep the comparator's collector currents and voltages closely matched, thereby making the circuit tolerant of supply line variations. The device is intended for use with thin film or discrete components to define the gain or other special functions.

The input d.c. offset voltage is 25 mV, the common-mode rejection ratio is 50 dB minimum and the change of gain with temperature over the range -25°C to $+100^{\circ}\text{C}$ is ± 6 dB.

WW 330 for further details

Mesh Oscilloscope Tube

THE type V3174 from Brimar, 7 Soho Square, London, W.1, is a sensitive cathode-ray tube intended for use in wide band oscilloscopes incorporating transistor deflection circuits. Under typical operating conditions it will display single phenomena on a screen 6×10 cm at bandwidths of up to 30 Mc/s. Fewer control voltages are required on this tube compared to other mesh tubes as the functions of the mesh, collector and geometry controls have been combined. The purpose of the mesh, as with any post-deflection acceleration technique, is to enhance brightness while still achieving deflection sensitivity. The mesh is in fact a large frame grid that is wound at 800 turns per inch, it is nearly transparent to the electron beam but it is opaque to the equipotential fields which restrict c.r.t. performance. In addition to the normal method of Z axis modulation via the grid, flyback blanking can be achieved at anode potential using the anode modulator.

WW 331 for further details

BAND III WIDE-BAND ARRAY

COMPLETE Band III coverage is given by the Astrabeam (ABM5) aerial manufactured by J. Beam Aerials, of Rothersthorpe Crescent, Northampton. It is a five-element array designed for television reception anywhere in the U.K. using either single or dual channel reception. Previous Band III models were designed for reception on two adjacent channels only. The aerial is a development of earlier J Beam marine aerials which were intended for multi-channel use. Bandwidth and coverage are shown in the diagram. The array costs 41s with mounting bracket and will be available in August.

WW 332 for further details

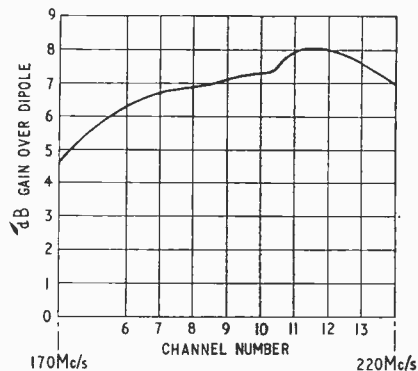



Ferrite Pot Cores

HIGH-permeability ferrite pot cores are available from S.T.C. in four I.E.C.-recommended sizes and in five grades of ferrite. Four- and two-slot cores are produced in adjustable and non-adjustable forms for inductor and transformer use. Inductance setting accuracy is claimed to be 0.01% over a wide range, the desired value being maintained under varying temperature and shock conditions. Cores are suitable for direct mounting on to printed circuits. The transformer ferrites include type SA500T for use up to 10 Mc/s, and a new ferrite type SA601 having very high permeability and thus enabling transformers to be made a size smaller than

Oxide Resistors

INTRODUCED at the exhibition by Electrosil Ltd. (P.O. Box 37, Pallion, Sunderland, Co. Durham) was the C5 range of tin-oxide-on-glass resistors, which are notable for having the low temperature coefficient of ± 100 p.p.m. over the range -55°C to $+175^\circ\text{C}$ with a normal statistical distribution. They have a high-temperature, moisture-resistant coating, and are intended to replace the makers' TR5 range in professional applications where improved stability and temperature coefficient are required. Like the TR5 and other Electrosil ranges they are "triple rated"—that is with a power rating of $\frac{1}{4}$ W they are considered as "semi-precision" with a rating of $\frac{1}{2}$ W "high stability," and with a rating of $\frac{1}{2}$ W "general purpose." The idea is that the customer can reduce the number of

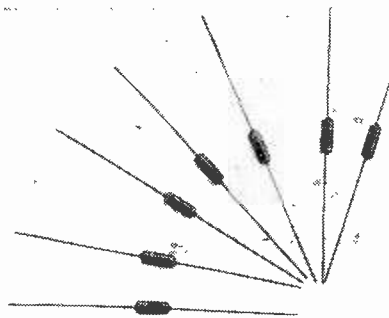

different types of resistors that he has to stock, and can purchase the resulting greater quantities of the one type at a lower price. Values from $10\ \Omega$ to $1\ \text{M}\Omega$ with tolerances of 1%, 2% or 5% are available.

WW 333 for further details

with SA500T units. Inductor materials are for use up to 300 kc/s and include SA502 for tuner circuit use with mica capacitors (zero temperature coefficient) and SA 503 with a positive temperature coefficient and for use with polystyrene capacitors. A low-cost type similar to the SA503 is available (SA500L). S.T.C. Magnetic Materials Division, Edinburgh Way, Harlow, Essex.

WW 334 for further details

Relay With Transistor Amplifier

OPERATION of the B and R relay type B07 can be carried out with either a sensitive thermostat or low-power signal; the minimum signal for satisfactory operation being 700 mV, 250 μA , and 175 μW . In temperature control, where the relay is to be operated by a thermostat, by using alternative pin connections the contacts can be arranged to make only when the thermostat makes; alternatively, to make immediately the supply is connected, and to break when the thermostat contacts open. This latter arrangement provides a "fail to safe" operation. This plug-in relay with a transistor amplifier operates from an a.c. or d.c. supply of 24 V, the necessary rectification being incorporated within the relay. The standard version B07 is fitted with one normally open heavy duty contact rated at 5 A, 240 V, a.c., although provision is made (internally) for uprating these figures to 15 A at 240 V. It can also be supplied with c/o contacts at 5 A 250 V a.c. or 30 V d.c. non-inductive. B. & R. Relays Ltd., Temple Fields, Harlow, Essex.

WW 336 for further details

Elliott Integrated Circuits

A NUMBER of m.o.s. integrated circuits were shown in addition to the Elliott range of silicon i.c.s. (These last circuits are equivalent to the Fairchild DT μ L930, TT μ L9000, and μ A7700 ranges.) The m.o.s. circuits include a dual NOR gate, a hybrid audio switch and an eight-stage shift register, all in TO-5 cans. The interesting m.o.s. item is the audio line switch which combines analogue and digital circuitry on the same chip. The switch uses digital control logic for audio channel selection as might be required in communications equipment. The audio transmission is bi-directional along the two channels which are digitally controlled to be mutually exclusive. Selection of one channel has priority over the previous or subsequent selection of the second channel. A RESET pulse switches off both channels; a SET A pulse will switch on channel A and override channel B selection; a SET B pulse switches on channel B provided that channel A is already off. Signal levels for this particular development are 1 V r.m.s. and bandwidth extends to 50 kc/s. Elliott-Automation Microelectronics

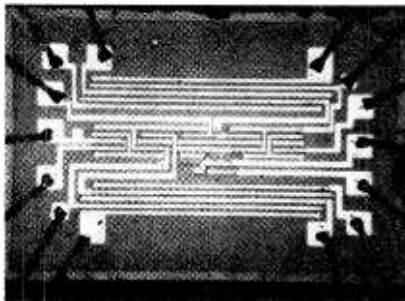

Ltd, Queensway Industrial Estate, Glenrothes, Fife.

WW 335 for further details

Bleep Speaker

A MINIATURE electromagnetic transducer (XD712) primarily intended for use in pocket paging systems was shown by Knowles Electronics Ltd., Victoria Road, Burgess Hill, Sussex. The unit, incorporates two coils, one being used as a normal voice coil and the other as

a feedback coil enabling the unit to be used as an audio tone generator resulting in an economy of components and space. The nominal impedance is 45 Ω at 1 kc/s, the feedback ratio is 1:10 and the tone frequency is around 4.5 kc/s.

WW 337 for further details

LCR BRIDGE

A GENERAL-PURPOSE, battery operated component measuring bridge with a price "under £100" was introduced at the exhibition by Avo Ltd., Avocet House, Dover, Kent. Balance is indicated by a centre-null meter and the value of the component measured is given on a 3-digit in-line display operated

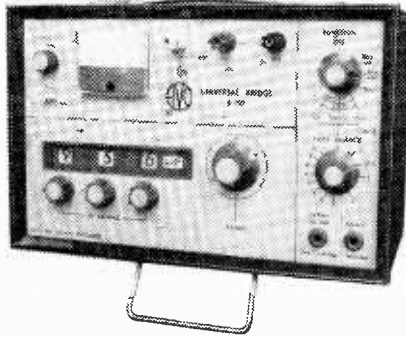

by the three balancing control knobs. Multiplying factors are not needed. Capacitance can be measured in eight ranges, from 119.9 pF to 1,199 μ F; inductance in eight ranges from 11.99 μ H to 119.9 H and resistance in eight ranges from 1,119 m Ω to 11.19 M Ω . Accuracy is $\pm 1\%$ of the reading ± 1 digit. For a.c. measurements of L, C and R, an internal 1 kc/s oscillator is used, and for d.c. measurement of resistance there is an internal 9 V battery, but external a.c. and d.c. sources may be connected if required. Also, external polarizing voltages up to 500 V may be applied for testing electrolytic capacitors. A facility is included for checking the instrument's battery to ensure that its voltage is above the minimum needed for satisfactory operation. Designated B150, the bridge has transistor circuitry and weighs about 11 lb.

WW 338 for further details

Solid State Oscilloscope

A NEW oscilloscope in the medium price range has been introduced by Advance Electronics Ltd., Hainault, Essex, with modular plug-in electronics. Designated Type OS2000, it utilizes a five-inch rectangular tube with a helical p.d.a. operating at 4 kV and providing a 10 cm by 6 cm display area. Both single and dual trace plug-in Y units are available, the single trace unit has a bandwidth of d.c. to 20 Mc/s and sensitivity of 50 mV/cm; input impedance is 1 M Ω shunted by 35 pF. The dual-trace unit has a bandwidth of d.c. to 20 Mc/s at 10 mV/cm or, by cascading the amplifiers, 5 c/s to 5 Mc/s at

1 mV/cm. The measuring accuracy of both these plug-ins is $\pm 5\%$. The standard time base provides 19 ranges from 200 ms/cm to 0.2 μ s/cm in a 1, 2, 5 sequence. Trigger level can be manually set or synchronism can be automatic from 40 c/s to 20 Mc/s. The trigger source can be internal, external line, tv frame or the timebase can be free running. With the standard timebase and dual-trace plug-in the oscilloscope costs about £230. Other plug-in units under development are a high-gain differential amplifier and a sweep delay unit.

WW 339 for further details

Square-Law Converter

A DEVICE which will give a d.c. output voltage proportional to the square of an a.c. or d.c. input voltage, and can therefore be used for measuring r.m.s. values, is the Signacon, shown by Associated Electrical Industries Ltd., Power Protection and Meter Dept., Trafford Park, Manchester 7. It is basically a thermo-couple, but has a plurality of closely spaced, series-connected, thermo-junctions which are in intimate contact with, but insulated from, a bifilar heater. The whole device, housed in a copper case, is evacuated. The output is 120 mV nominal, and heater capacities of 10 mA, 30 mA and 50 mA are available. Two versions are being produced, one with a single heater and



the other, a differential type, with two heaters. A limitation of the converter for some applications is the slow response due to thermal delay—it takes approximately 10 seconds for the output to come within 0.1% of the final value. When the input is a.c., the Signacon will operate with input frequencies up to 100 kc/s.

WW 340 for further details

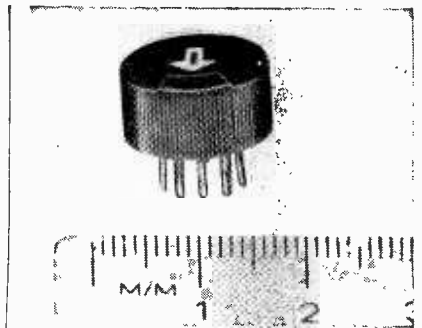

Miniature 10-turn Potentiometer

MINIATURE thumbwheel potentiometer measuring $0.7 \times 0.7 \times 0.3$ in is the latest in a range made by Painton & Co. Ltd., of Kingsthorpe, Northampton. The track is single-turn (290°) only but the knurled thumbwheel is geared to give 10 turns. Typical mechanical life of the arrangement is given as 50,000 cycles. A slipping clutch is included which prevents damage from forced adjustment. Sub-divided scale markings of 0-10 are provided. Potentiometers with resistance values in the range 50 Ω -50 k Ω are available at $\frac{1}{4}$ W power rating. Fixing can be by two 8 BA holes, a 90° angle bracket or by printed circuit pins.

WW 341 for further details

Inexpensive Instruments

A RANGE of three inexpensive instruments has been announced by Sign Electronics. These include the type AM 324 audio millivoltmeter and the S 324 audio signal generator. The millivoltmeter incorporates a taut band suspension meter and covers 1 mV to 300 V in twelve ranges between 10 c/s and 1 Mc/s with an accuracy of $\pm 3\%$ of f.s.d. High stability resistors and silicon planar transistors are used throughout the audio generator which will provide a one volt sine wave into 600 Ω from 6 c/s to 60 kc/s in eight one-third decade bands. Distortion is quoted as being less than 0.05% from 100 c/s to 10 kc/s and stability as better than one part in 100,000 per hour one minute after switch on. Both units will operate from PP9 batteries or a mains power supply unit that is available as an optional extra. Prices are £66 for the AM 324 and £59 for the S 324 and they are available from Avelly Electric Ltd., South Ockendon, Essex.

WW 342 for further details

MOBILE 6ft SATCOM TERMINAL

ON view among the British exhibits at the Paris Air Show was an experimental mobile satellite communications station developed by the Signals Research and Development Establishment, Christchurch, Hants. Although it is only experimental—actually an exercise in designing the smallest station capable of providing a useful service in military satellite communications—it does give some idea of what operational stations of this kind now being built for the British Army will probably look like. A similar sized station (though different in design) has been built by the Admiralty Surface Weapons Establishment and Plessey Radar for operation on Royal Navy ships (see February issue, p. 68) and has now been installed in the frigate *H.M.S. Wakeful* for trials at sea. Both stations, for global communications, are intended to work with large fixed ground stations, and have been operating through a group of 16 near-synchronous satellites provided by the U.S. Department of Defence under a U.S. trials programme called the Interim Defence Communications Satellite Programme, in which the U.K. and N.A.T.O. are taking part.

The S.R.D.E. station, which has been described as a "mobile Telex with global capability," includes a trailer-mounted equipment with a 6-ft steerable aerial dish, and so far has been operating simplex with one teleprinter channel—though its capacity, working through an I.D.C.S.P. satellite, is actually 50 teleprinter channels or one speech channel. It has been constructed from commercially available components. The microwave transmitter (8 Gc/s) and receiver (7 Gc/s) are mounted behind the aerial dish, while other terminal equipment, including a teleprinter, aerial position-control equipment and a petrol-electric generator, is carried in a Land-Rover vehicle which tows the trailer.

The transmitter has a klystron r.f. output amplifier giving an output power of 1 kW c.w. This is driven by a varactor frequency multiplier ($\times 200$), the input to which is an f.s.k. signal from two crystal oscillators (teleprinter "mark" and "space") controlled through a modulator by the teleprinter signals. From the klystron the microwave power output is fed by waveguide via for-

ward and reverse power couplers, a waveguide switch, a transmit/receiver combiner and circular polarizer to the parabolic dish aerial. Circularly polarized beacon and information signals picked up from the satellite are transformed to linear polarization and passed via a waveguide switch to the receiver, which has an un-cooled parametric amplifier for the low-noise first stage, a crystal local oscillator followed by a $\times 200$ varactor frequency multiplier, a mixer and an i.f. amplifier. The high-level i.f. signals are passed to the terminal equipment in the Land-Rover, where they are split to beacon and information receivers and the demodulated f.s.k. signal is fed to the teleprinter.

The aerial dish, which can move in azimuth $\pm 270^\circ$ and in elevation from -2° to $+92^\circ$, is position-controlled either from a punched tape in 0.2° steps or manually. This enables the aerial to be pointed at any available satellite in the I.D.C.S.P. system, and the station will in fact operate satisfactorily with satellites in positions down to 5° of elevation.

Conferences and Exhibitions

LONDON

- July 3-5 Imperial College
Electron Diffraction
 (I.P.P.S., 47 Belgrave Sq., S.W.1)
- July 17-22 Imperial College
I.Q.S.Y./COSPAR Joint Scientific Symposium
 (I.Q.S.Y. Secretariat, 6 Cornwall Terr., N.W.1)
- July 24-28 Imperial College
COSPAR International Space Science Symposium
 (I.Q.S.Y. Secretariat, 6 Cornwall Terr., N.W.1)

BIRMINGHAM

- July 6-7 The University
Accuracy of Spectroscopic Methods
 (I.P.P.S., 47 Belgrave Sq., London, S.W.1)

MANCHESTER

- July 18-20 The University
Computer Technology
 (I.E.E., Savoy Pl., London, W.C.2)

NOTTINGHAM

- July 10-13 The University
Integration of Design & Production in the Electronics Industry
 (I.E.R.E., 9 Bedford Sq., London, W.C.1)

OVERSEAS

- July 3-8 Warsaw
IMEKO—International Measurement Congress
 (Society of Instrument Technology, 20 Peel St., London, W.8)
- July 3-11 Warsaw
IMIS—International Measurements & Instruments Show
 (IMIS, Muzeum Techniki, Palac Kultury i Nauki, Warsaw)
- July 10-14 Columbus
Nuclear and Space Radiation Effects
 (I.E.E.E., 345 E. 47th St., New York, N.Y. 10017)
- July 18-20 Washington
Electromagnetic Compatibility
 (I.E.E.E., 345 E. 47th St., New York, N.Y. 10017)
- July 18-23 Paris
Laser Applications Conference & Exhibition
 (M. Locquin, 38 ave George V, Paris 8e)

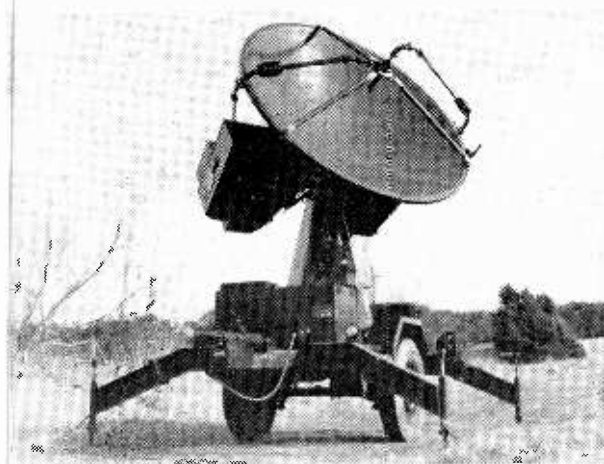

Trailer part of station set up for operation.

Spot Beam Photoelectric Relay

By P. COWAN

THE photoelectric device to be described is capable of detecting objects down to $\frac{1}{8}$ in diameter at a range of 10 feet and when used with a halo eliminator objects of $\frac{1}{16}$ in diameter can be detected at reduced range (2 ft). The light source requires little description as reference to figure 1 will show. An aluminium disc with a central 0.04 in hole is fitted into the bulb holder, a suitable insertion tool is illustrated in the inset. The original lens is discarded and a 1 in diameter, $1\frac{1}{4}$ in focal length convex lens is fitted in its place. Illumination is provided by a 2.5 V, "lens end," bulb that is under run at 1.8 V, a life of roughly 500 hours can be expected whilst running the bulb under these conditions. If greater resolution is required, at the expense of range, a halo eliminator may be incorporated. This is provided by clamping a further metal disc with a 0.04 in central hole between the lens and bezel, ranges of greater than about 2 ft are not a practical proposition with the reduced spot size so obtained.

A bulb with an accurately positioned filament and a uniform spot is required by the unit; bulbs were found to vary considerably from sample to sample in this respect, rendering careful selection necessary. On average about one bulb in every four tested was found to be suitable.

If it is desired a piece of Kodak Wratten No. 88A filter may be fitted to the light source making the beam invisible, however, the range is reduced. This can be compensated for by increasing the lamp voltage to 2.5 V if reduced lamp life can be tolerated (≈ 100 hrs).

The amplifier circuit is shown in figure 2 (a). When the light cell is illuminated the base of the ACY19 is effectively short circuited to ground. As this illumination is removed the base voltage increases as does the voltage across the zener diode. When the zener breakdown voltage is reached base current flows and the relay

energises. The OA 81 protects the transistor from transient high voltage surges.

The amplifier is constructed on a small disc of printed board as shown in figure 2 (b & c). The bulbholder is removed from the Bulgin lamp housing by drilling out the central rivet, and discarded, the bakelite at the end of this housing is filed away so as to form an open ended cylinder. A small Tufnol disc is manufactured as per figure 2 (b) and secured to end of this cylinder with Araldite or some similar adhesive. The printed circuit is attached to this disc by means of short screws. The rest of the lampholder is modified and assembled as per figure 4. I am indebted to my company (Reckitt & Sons Ltd.) for permission to publish this article.

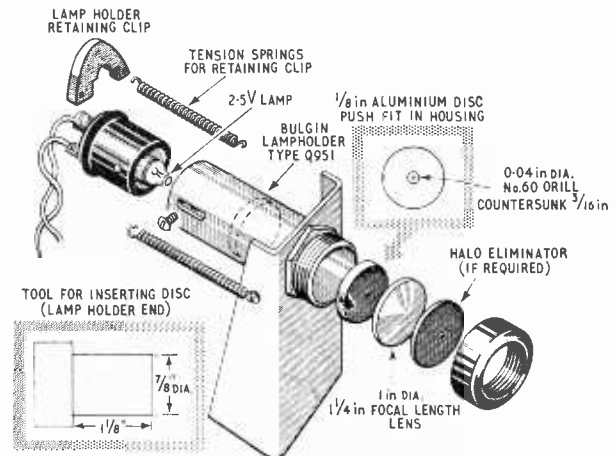

Fig. 1. The light source

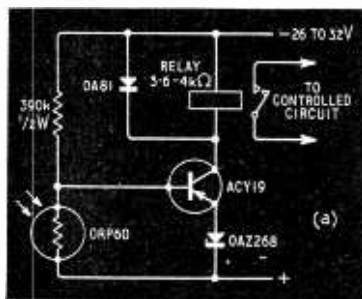
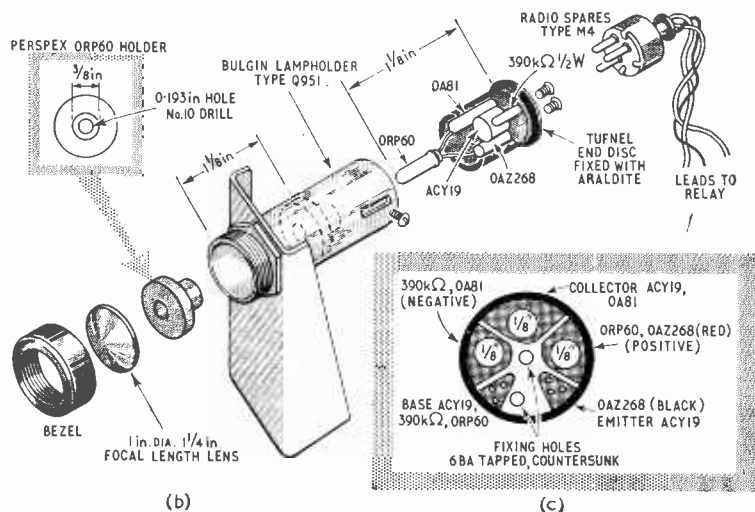

Fig. 2. Detector construction and amplifier circuit.



NEWS FROM INDUSTRY

DOMESTIC RECEIVER MANUFACTURERS' PROBLEMS

IN a speech given by Sir Jules Thorn, president of the British Radio Equipment Manufacturers' Association (BREMA), at their annual general meeting he said that during the past two years annual turnover had dropped from £107M to £73.5M. "It is doubtful whether any industry has been more adversely affected than ours by the Government's restrictive measures, clearly indicating that we have once again borne the brunt of the Government's deflationary policy." He entirely repudiated the recent criticism that industry was dragging its heels on colour as production plans are on schedule bearing in mind that the Government's policy on this subject was not clarified until February this year. Because the B.B.C. have decided to launch colour on July 1st, four or five months earlier than expected, he stated that an initial shortage of receivers was inevitable but by the end of the year the production rate would be more than adequate to meet consumer demand. "We recognize that the long-term potential of colour is enormous and the future of the industry is dependent upon our meeting the challenge which this represents."

He thought that the proposed addi-

tional licence fee for colour of £5 would not bring in much revenue in the early stages and could well impede growth and if considered essential the introduction of the increased fee should be postponed until all three programmes were being transmitted in colour.

The BREMA annual report states that the total demand for radio receivers has decreased particularly in respect of home produced receivers while imported sets have captured a larger share of the reduced market. The total number of home produced sets despatched to the trade in 1966 was reduced by 21% to 1.364M compared to the previous year, while the share of the U.K. market held by imported receivers increased from 1.548M to 1.719M although the value did not increase in the same proportion. A number of these receivers, 49,000, were imported by British manufacturers and sold under their own brand names.

The increases in hire purchase deposits and rental down payments in February and again in July (1966) had a disastrous effect on the market during the second half of the year, and it is estimated that by mid-1967 such restrictions will have reduced the total annual television market by more than half a million sets.

The British Aircraft Corporation's tactical anti-aircraft weapon, Rapier, was fired for the first time at a "live" target on the Royal Aircraft Establishment's range at Aberporth, Cardiganshire, with considerable success. The Rapier system is under development by the Guided Weapons Division of B.A.C. who are working in close collaboration with Decca Radar and is intended for use by the British Army and the R.A.F. Regiment. For the test firing a Meteor Aircraft flying at an altitude of 3,000ft was used as the target, presenting Rapier with a crossing target at a range of 10,000 ft, a direct hit was scored. This company have formed a new division at their Bristol works to handle the Guided Weapons division's activities in the field of space and instrumentation. Work to be undertaken by the new division will include scientific and communications satellites, experimental space electronics and p.c.m. telemetry. The flight test recording system for Concorde comes under the last heading and is the largest capacity system made for this type of application.

The Decca Navigator Company have set up a "Systems Study and Management" department to carry out advanced design studies on new techniques and products for use in marine, air and survey environments. The services of the department will be available to both civil and military air and marine organizations at home and abroad.

Storno Ltd. have received another contract from the Metropolitan Police to supply 1,800 two-way personal radio sets type 500R. Contact between patrolling officers is maintained by means of fixed base stations located at strategic points. When fully established the system will provide complete coverage of the Metropolitan Police area. A feature of the design is that messages transmitted by Scotland Yard can be automatically given priority at the base station ensuring immediate broadcast of urgent messages to policemen on the beat.

EMI Electronics have opened a new ultrasonic research facility at their Feltham laboratories that will be used primarily to investigate the radar cross-section of aircraft and other radar targets with the aid of scale models. The initial research work on the application of ultrasonic to simulate radar was carried out at R.A.E. Farnborough. The facilities available at Feltham include a large concrete pool which houses an ultrasonic source and a test target, both of which can be moved with a high degree of positional accuracy by closed loop servos coupled to an Emicon B100 numerical control system. Control can be obtained by punched tape or manual methods while the operator has a clear view of both the source and the target by means of a closed-circuit television system.

AEI Electronics have received a £12,000 order from British Railways for their Clearcall communications system to be installed on the coal trains that run on the Manchester-Wath-Sheffield line. Each train has four locomotives, two at the front pulling and two at the rear pushing, each pair of locomotives is controlled by one driver so it is essential that some form of communication system exists between the two drivers, and between each driver and a control point. A communication link between the control point and the drivers is established by injecting a modulated 100 kc/s carrier wave into the 1,500 volt overhead power line, this being received and demodulated by equipment on the train. The driver to driver link is carried out by conventional intercom techniques.

Multicore Solders Ltd. of Hemel Hempstead have developed a means of producing small cylindrical pellets of solder which should substantially reduce the cost of automatic soldering processes where a small precise weight of solder is required for each joint. Previous solder preforms have proved rather expensive because of the amount of scrap produced during their manufacture, these have been in the shape of either discs or spheres. The new process enables pellets to be cut to an accuracy of 0.001in. in length from a drawn wire and does not result in the formation of scrap. The pellets can be supplied with or without flux in a range of high and low melting point tin/lead alloys to British and U.S.A. specifications some of which contain a percentage of silver. Virtually any size of pellet is available the smallest having a length of 0.020 inches and a diameter of 0.022in.

G.E.C. Road Signals Ltd. and The Marconi Company Ltd. have agreed to collaborate in the field of computer controlled area road traffic signalling schemes in the U.K. and overseas. Area traffic schemes will be put forward by G.E.C. Road Signals Limited, who will provide the road signalling equipment, while Marconi will provide the central data processing systems. This collaboration will also provide customers with a wide and competitive choice of associated equipment, such as closed-circuit television, from the ranges of the two companies or from other sources. The joint activity will be centred on the offices of G.E.C. Road Signals Ltd., at East Lane, Wembley.

Technograph and Telegraph Ltd. have been awarded a research and development contract by the Ministry of Technology to study improved techniques for multilayer printed circuit manufacture. The investigation will involve the study of new materials, interconnection techniques, bonding and etching procedures.

Redifon Ltd. have announced that they intend to change the name of the recently acquired company General Precision Systems Ltd., of Aylesbury, to Redifon Air Trainers Ltd.

Wayne Kerr has been awarded a contract worth more than £1M. by the Ministry of Technology for the development of a precision Attenuator Calibrator. Error must be less than 0.005 dB up to 100 dB from 200 Mc/s to 10 Gc/s and a capability of 150 dB over the same frequency range must be achieved. Measurements are referred to an internal standard piston attenuator operating at 60 Mc/s. The piston has an effective length of 16 cm and physical dimensions are such that taper and ovality must not exceed 1 micron.

Relifon Ltd have received an order from Cable and Wireless for transmitting equipment to be installed at coast stations in Hong Kong, Barbados, Aden, Bahrain, Bermuda, Guyana, Malta and Jamaica. Each transmitter has an output power of 2.5 kW and two r.f. units enable them to operate on two frequencies in the marine band; they will be used to handle ship-to-shore traffic. Where an installation consists of two transmitters selection of several different working frequencies is possible by means of a tone remote control system.

The Marconi Company have sold a Marconidata transmission system to Czechoslovakia to be used by the Ministry of Transport (Railways) Research Institute for evaluating the use of the telephone system as a means of data transmission. By making a telephone call the operator can transfer information from a punched paper tape to a remote computer with a high degree of error protection, less than one character in ten million will be transmitted incorrectly.

Apparatebau Oswald Haussmann, of West Berlin, have announced that their sole representation in the U.K. has been transferred to Selig Electro-Magnetics Ltd., 2 Powis Gardens, London, N.W.11. The range of products includes push-buttons in a variety of configurations.

Unimax Switch Ltd is a new company that has been formed by the Maxson Electronics Corporation, of New York, and Appliance Components Ltd, of Maidenhead. This new Anglo-American Company will market and manufacture micro-switches and other related products and will be housed at Cordwallis Estate, Maidenhead, Berks.

The Weller Electric Corporation, of Easton, Pennsylvania, U.S.A., announce the formation of two new companies, one in Canada and the other in the U.K. The English company, Weller Electric Ltd, Redkirk Way, Horsham, will manufacture and assemble a range of soldering instruments.

A.B. Metal Products Ltd., Abercynon, Glamorgan, are establishing a subsidiary company in Werne a.d. Lippe, Germany, which will be known as A.E. Elektronik G.m.b.H.

Mullard Ltd have introduced a new quantity price structure for valves. An agreement with H.M. Customs and Excise results in a lower rate of purchase tax on quantities of 36 valves of mixed types.



THE HOUSE OF BULGIN AT YOUR SERVICE

ADDITIONS TO OUR LARGE AND VARIED STOCK



List No. S.I.B.825/Col.



List No. B.12



List No. S.A.2368



List No. S.A.2367

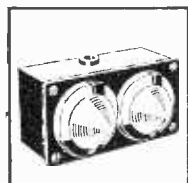

List No. DEV.1914/1

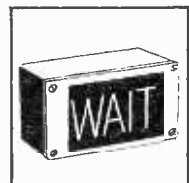

D.882/Col/Leg.

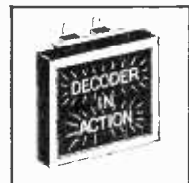

D.716/M'SS/Col/Leg.



List No. D/S.753/Col.



List No. D.926



List No. E.H.24

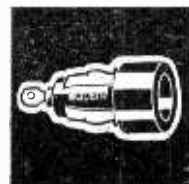

List No. P.542



List No. F.296

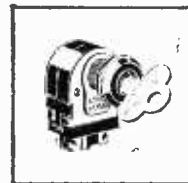

List No. S.M.320

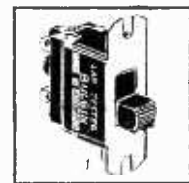

List No. S.M.593

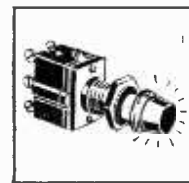

List No. D/S.934/Col.

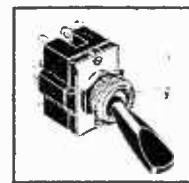

List No. S.M.270/D.B.



List No. K.544/K.C.1



D/S.936/Col/Leg.



M.P.22/Col.



List No. K.493

Send for our comprehensive components catalogue 5/- post free or free to trade letterhead on order

A. F. BULGIN & CO. LTD.,
Bye Pass Rd., Barking, Essex.
Tel: RIPpleway 5588 (12 lines)

MANUFACTURERS AND SUPPLIERS OF RADIO AND ELECTRONIC COMPONENTS TO

ADMIRALTY	MINISTRY OF WORKS	B.C.
WAR OFFICE	MINISTRY OF AVIATION	G.P.O.
AIR MINISTRY	MINISTRY OF SUPPLY	I.T.A.
HOME OFFICE	RESEARCH ESTABLISHMENTS	N.P.L.
CROWN AGENTS	U.K.A.E.A.	D.S.I.R.

WW-095 FOR FURTHER DETAILS

Merlin, where art thou?

THE electronics industry tends to regard itself as the elephant's bedsocks when it comes to communications, but I'm not so sure. I think they did it much better in ye olde days. King Arthur, for instance. Whenever he felt a need to keep the royal sinews in fettle, all he had to do was to go down to the castle laboratory and get Merlin to do a single-frame scan over the crystal ball to see what was happening in the outside world. Well before Arthur had time to buckle on Excalibur, there was Merlin reporting that three leagues hence a dragon was dishing out insulting behaviour to a fair damsel, and in no time at all a sheriff's posse of one would be off across the draw-bridge.

Somewhere along the line we seem to have lost the knack, and as I see that last year the turnover of the domestic radio side of the industry went down by £20,000,000, the sooner we get it back the better, because there's a gold-mine in it for somebody.

One of the paradoxes of our calling is that while we're devilish clever at linking places thousands of miles apart we seem to be completely stymied when it comes to getting in touch with potential purchasers of the goods we have to offer unless they also happen to be in electronics; which mostly they aren't.

To see why this is so, let us suppose that somewhere Manchester way there is a manufacturer of mini-skirts—as no doubt there is—and that somewhere in his factory there is a stage in the process where a little black box of electronic gubbins, judiciously applied, would speed the output n times or reduce the reject rate appreciably. But you, Mister Textile Manufacturer, know nothing of electronics while we for our part know nothing of mini-skirts manufacture, although fully appreciative of the use to which the end product is put. In brief—and no pun intended—between us and you there is a great gulf fixed. You are in the market for what we have to offer; we should be delighted to sell it to you. But no deal, because there is no communication.

But before we shoot the poor old electronics manufacturer for incompetence, let us remember two points which further gum up the works. The first is that the industrialist may well be happy with things as they are until he is forcibly convinced that they could be even better. The second is that it is unlikely that an off-the-shelf electronics device is going to slot neatly into the manufacturing process; the equipment may exist in no more tangible form than design capability. Besides, purely electronic devices cannot do anything in isolation; they usually have to be linked to processes through mechanical actuating systems or sensing devices introducing mechanical and other physical variables.

What then, can be done? It's no use hunting for Merlin; he isn't around any more. So it seems to me that the only way to get this kind of business is to go and find out exactly how mini-skirts are made; or jam; or tea-cups; or lawn-mowers, or a hundred-and-one diverse articles. For this we need a team of engineers of a special kind; in fact a species which seems to be dying out—the inventive type. One of these would go to a given factory for a month and study every process, noting possible applications of electronics and reporting back to base, where in due course a prototype could be produced.

You will have noticed that in the short list of examples I have given above, no mention of big industries such as car manufacture or the steel industry was made. This was with intent, for the big industrial concerns are getting wise to the value of electronics and often maintain a department of their own to watch out for applications. But the smaller fry (even though possibly of considerable size) have not, and these are the ones we should be after.

It can be argued that to go to all this trouble wouldn't pay for doing, and perhaps it might not for the big electronics boys with commensurate overheads. But this leaves the field open for the little man to step in and try his luck, for often nothing more complex than a photo-cell application or a temperature-operated alarm circuit or the like is demanded, and this brings the exercise well within the capabilities of a small electronic engineering establishment with capacity to spare or even a retail radio service department. And, provided integrity is brought to bear, there is gold in them thar mills because the chances are that if a device is useful in one factory it will be of equal importance to lots of kindred organizations both at home and overseas.

So far so good. By establishing communication with the manufacturer and by working on the information gained, we now have some specific hardware to offer instead of nebulous design facilities. The next stage is to spring to the stirrup and carry the good news. Here again there is a communications gap because although there is a proliferation of journals which deal with new electronics products, the reports might as well be in Chinese as far as our customer is concerned. The fact that your black box will accept an input of $100 \mu\text{V}$ into $2 \text{ k}\Omega$, uses a new form of ferrite, has a flat response from 10 to 60000 Hz and a sig/noise ratio of better than 75 dB does not raise the temperature of a mini-skirt manufacturer one iota. In his world an ohm is the place that always seems to need redecorating, a ferrite is an animal that chases rabbits through holes and Hz are his favourite trumps. He has his own technical journals and it is through these that he can be reached, provided you talk to him in his own language. Over and above these however, there does seem to be a crying need for an industrial equivalent to "Which?"

There are, naturally, various ways of tackling the initial investigation problem. It could form part of a service to the industry on the part of the Ministry of Technology or by one of the industry's associations, the main snag about this being that instead of sending one investigating engineer they would be prone to send a full-scale committee of Ph.Ds. But whichever way it is done it wouldn't hurt the industry at large to come to grips with the thought that the provision of transistor radios and guitars to the juvenile population is not its main function in life and that there is a great future in electronics as a service to other manufacturers. As to initial costs, well, you could send an awful lot of engineers out into the highways and by-ways for £20,000,000.

Who knows? In the fullness of time we might even have a reverse situation in being, in which delegations from other industries came to see how they could help us. There are distinct possibilities; the installation of a bevy of mini-skirted models would certainly raise the ambient temperature of the laboratories on a raw February morning.



*A Service
to
Industry!*

TEMPERATURE CONTROLLED
WITHOUT MECHANICAL
DEVICES

SPECIALIST DESIGN
MEANS ONE INSTRUMENT—
ONE JOB IS ECONOMICALLY
SOUND

ALL ADCOLA SOLDIERING
EQUIPMENT IS BACKED BY
THE FULLEST AFTER SALES
SERVICE

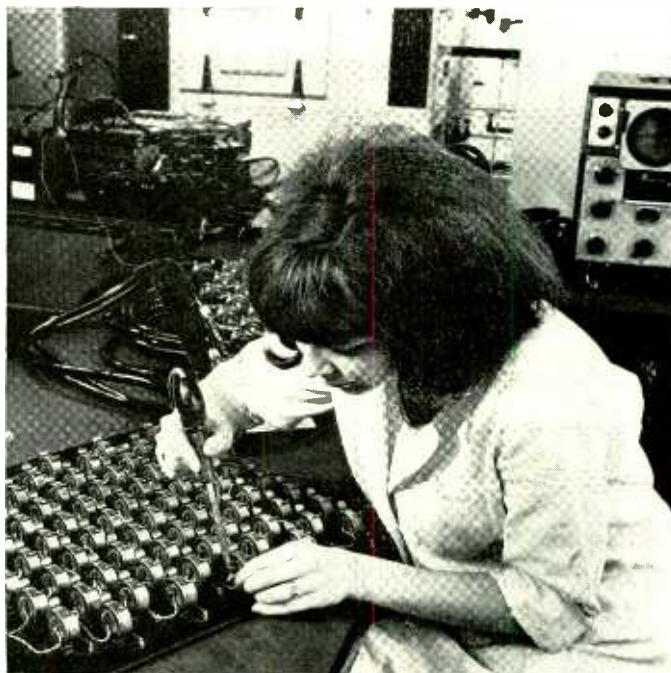

Photograph by courtesy of
Thorn Electronics Ltd.

*For full information
and sales apply direct to*

HEAD OFFICE SALES & SERVICE

ADCOLA PRODUCTS LTD
ADCOLA HOUSE, GAUDEN ROAD,
LONDON, S.W.4.

Telephones: 01-622-0291/3 Telegrams: SOLJOINT, LONDON, S.W.4

AUSTRALIAN ASSOCIATES: ADCOLA PRODUCTS PTY. LTD., 673 WHITEHORSE ROAD, MONT ALBERT, MELBOURNE
AGENTS IN ALL LEADING COUNTRIES

HUNDREDS OF THOUSANDS OF SOLDER JOINTS ARE MADE IN EACH PENTEX ELECTRONIC TELEPHONE EXCHANGE MANUFACTURED BY PLESSEY TELECOMMUNICATIONS

Ersin Multicore 5 Core Solder, 60/40 alloy, was chosen by the Plessey Company to make speedy, accurate and reliable solder joints on the assembly of the new Pentex Electronic Telephone Exchange, as this highly complex piece of equipment is designed to last many years in service without attention. It is also for this reason that Ersin Multicore 5 Core Solder for many years has been used by leading telephone manufacturers throughout the world on their equipment. It is approved by the British G.P.O. and many foreign telephone authorities. Whatever the application—the speedy soldering of miniature components, or the individual production of large units—there is an Ersin Multicore Solder which is exactly right for the job.

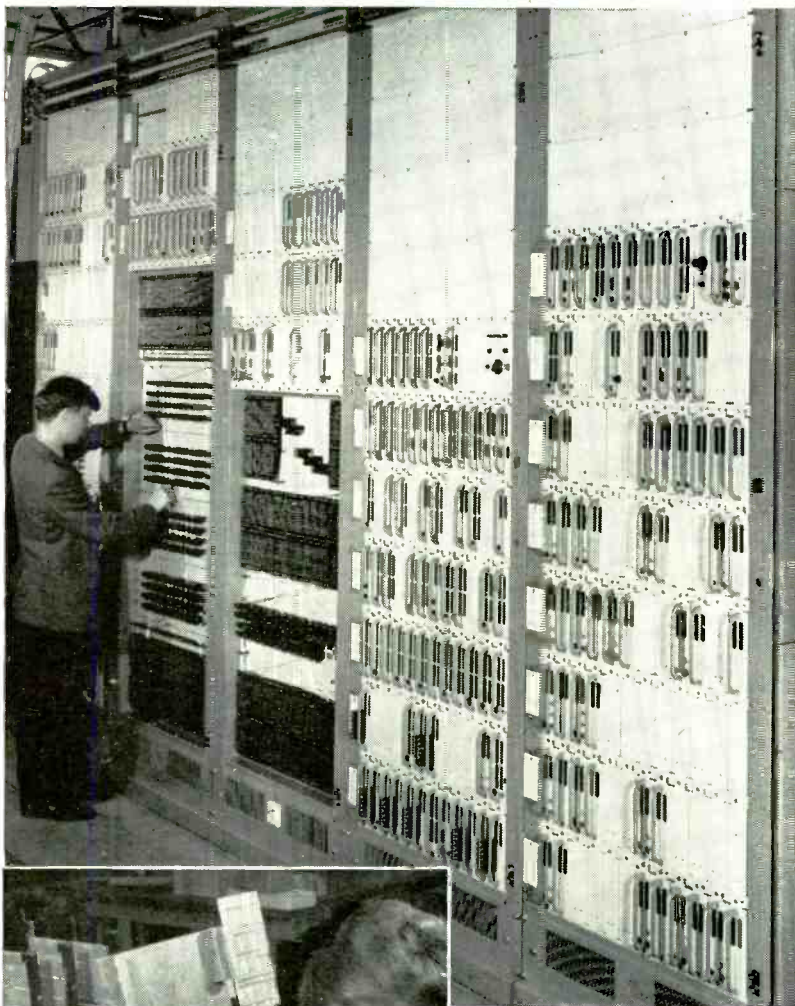

The complete Pentex Electronic Exchange shown above, is the first electronic exchange in full production in the U.K. The Pentex system was developed as the solution to the problem of speeding the routing of calls through exchanges. Exchanges with up to 2,000 lines are now being manufactured as part of the British Post Office Expansion Programme.

Ersin Multicore 5 Core Solder being used on one of the component parts of the Pentex system. The compact design and construction should be carefully noted.

ERSIN

Multicore

5 CORE SOLDER

Engineers and Technicians are invited to write on their Company's letterheading for the new 7th Edition of Modern Solders which contains comprehensive information on the full range of Ersin Multicore Solders, Soldering Machines and Solderability Test Machine.

MULTICORE SOLDERS LIMITED,

Hemel Hempstead, Herts.

Telephone: Hemel Hempstead 3636. Telex: 82363.

